

***clei***

LIVING  
SYSTEM



Anna Sator

# LIVING SYSTEM

design & technology

# LIVING DAYS AND NIGHTS

La forza delle idee, il fascino dell'ingegno

Living system

design pierluigi colombo

Programma componibile integrato con sistemi trasformabili brevettati per l'arredamento dello spazio giorno e notte. La versatilità dei sistemi trasformabili coordinati per prestazioni permette di progettare soluzioni di elevato contenuto estetico e multifunzionali per stili di vita./

Modular furniture program integrated to patented transformable systems to furnish the living and the night areas. The versatility of the transformable systems allows great and multi-function solutions for every life style

/ Programme composable intégré à systèmes transformables brevetés pour l'ameublement des espaces jour et nuit. La versatilité des systèmes transformables permet de projeter solutions à grand contenu esthétique pour tous les styles de vie. / Modulare patentierte Schlafzimmerlösungen integriert in verwandelbare Systeme für die Möblierung der Tag- und Nachtbedürfnisse des Lebens. Die Vielseitigkeit der wandelbaren Systeme ermöglichen die Multi-Funktions-Lösungen für jeden Lebensstil.

/ Programa componible integrado con sistemas transformables breveta- dos para el arreglo de l'espacio dia y noche. La versatilidad de los siste- mas transformables coordinados para prestaciones permite proyectar soluciones de elevado contenido estetico y multifuncionales para todos los estilos de vida.

# ONE MORE ROOM

Privilegi e vantaggi esclusivi.



LIVING



WORKING

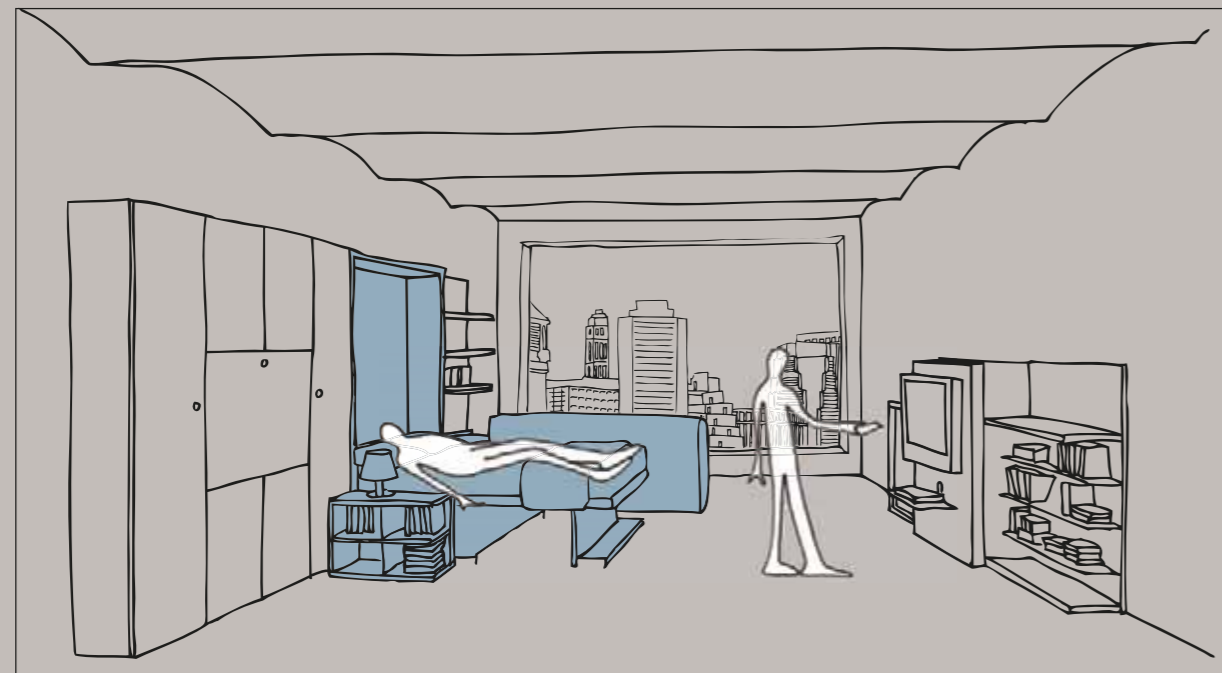

SLEEPING

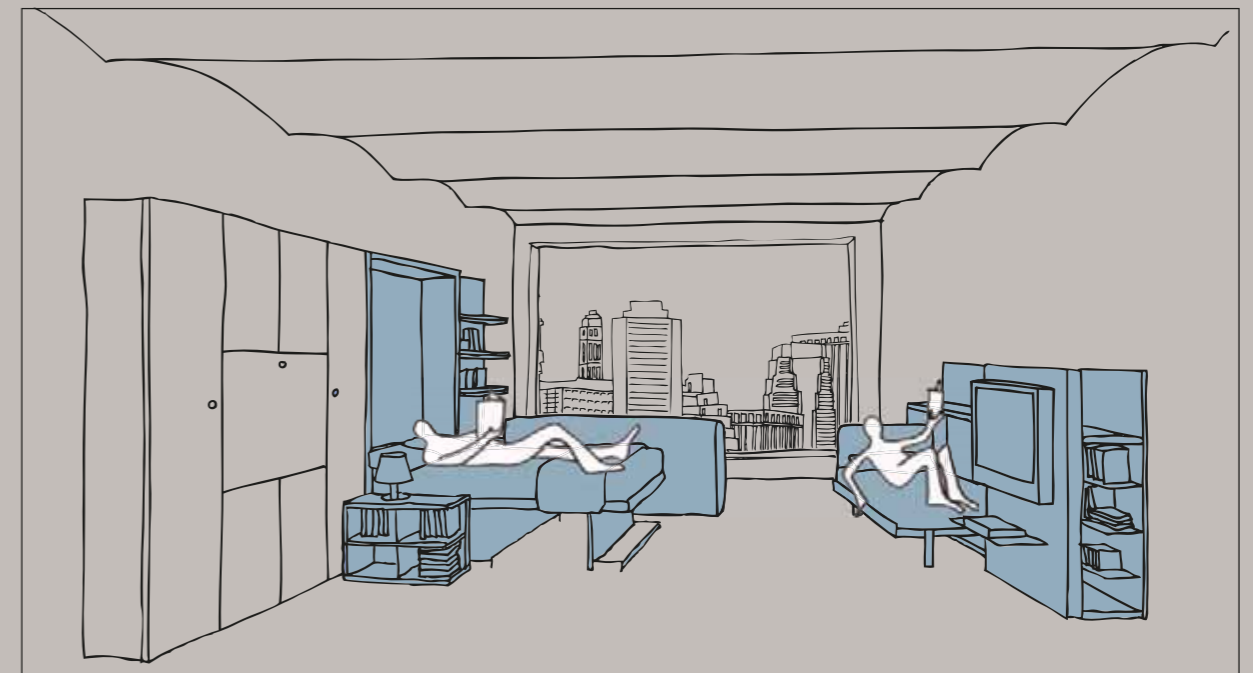

SLEEPING 2+1

# CLEI SYSTEM

# YOUR TOTAL LOOK

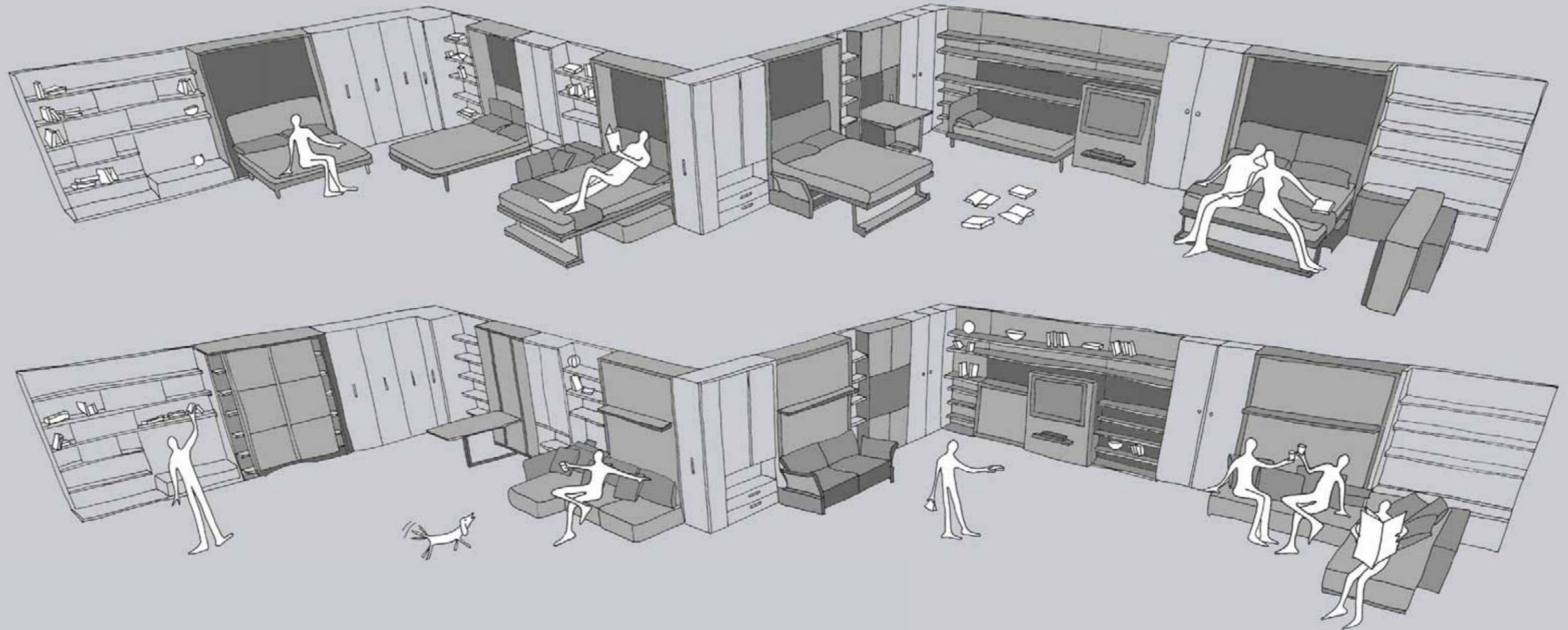

UNA STORIA  
DIVERSA DA TUTTE  
E INEGUAGLIABILE

GLI **ORIGINALI** CLEI  
IN PASSERELLA  
...BUONA VISIONE

\* A story different from any other one. The real clei products on parade... Enjoy it / Une histoire différente de toutes les autres et inégal-able. Les originaux clei en passerelle . Bonne vision / Eine Geschichte wie kaum eine andere. Die original clei Produkte auf dem Laufsteg... Enjoy it / Una historia diferente a todas e inegalable. Los productos originales clei en pasarella... Buena vista.





Swing

Atoll 202

Atoll 000





# Rete Cfg7

## Rete CFg7

Il sistema rete trasformabile è realizzato in estruso di alluminio anodizzato, con fissaggio del pannello di finitura della facciata che non necessita di ferramenta. Il sistema di bilanciamento del meccanismo abbattibile è dotato di fermo di sicurezza, senza tiranti e molle a vista, essendo questi inseriti nel telaio con sistema regolabile (fig. 1-2).

Il telaio viene integrato nella struttura del mobile e scorre nelle fasi di apertura e chiusura, su camme in polizene. Supporti e giunti sono realizzati con appositi stampi e fusione (fig. 3-4).

Apertura e chiusura si eseguono con un semplice gesto, mediante la maniglia posizionata sulla mensola di facciata, che con movimento basculante diventa il supporto del letto a terra e che restando sempre parallela al suolo nella fase di apertura, consente di non rimuovere gli oggetti riposti sulla stessa (fig. 2).

## Bed base CFg7

The transformable bed base system is made of anodized extruded aluminum; the installation of the front panel is done with no hardware.

The balancing system of the tilting mechanism is provided with a safety stop, with no tie-rods nor springs at sight, since they are inside the frame with adjustable system (photo 1-2).

The frame is integrated in the structure of the unit and slides during opening and closing on polyzene cams. Supports and joints are made on proper moulds and fusion (photo 3-4).

Opening and closing are done by an easy movement, through a handle placed on the front shelf, that by a swinging movement becomes support of the bed on ground. Since this shelf remains always parallel to the floor, it is not required to displace objects on it while the bed opens (photo 2).

## SOMMIER CFg7

Ce sommier est réalisé en extrude d'aluminium anodisé, avec fixation du panneau de façade sans quincaillerie.

Le système d'équilibrage du mécanisme rabattable est prévu d'un arrêt de sécurité, sans tirants ni ressorts à vue, puisqu'ils sont insérés dans l'encadrement avec système réglable (photo 1-2).

L'encadrement est intégré dans la structure du meuble et glisse, pendant l'ouverture et fermeture, sur cammes en polyzène. Les supports et les jonctions sont réalisés par des moules fait exprès et fusion (photo 3-4).

Ouverture et fermeture par un geste simple, par la poignée placée sur la tablette de façade, qui, grâce à un mouvement basculante, devient support du lit sur sol et qui, étant toujours parallèle au sol pendant l'ouverture, permet de laisser les objets y placés dessus (photo 2).

## Bed Basis CFg7

Das wandelbare Bett Basis-System besteht aus einem eloxiertem Aluminium Rahmen, stranggepresst. Dieser stabile Rahmen ist selbsttragend.

Das Balancing-System des Klappmechanismus ist mit einem Sicherheits-Stop vorgesehen und bietet eine hohe Sicherheit, zum Ein- und Ausklappen. Die Technik ist in dem Rahmen eingebaut (Foto 1-2).

Der Rahmen ist in den Korpus integriert und läuft beim Öffnen und Schließen über spezielle Stop- und Sicherheitsnoppen. Unterstützt wird dies durch patentierte Sonderbeschläge (Foto 3-4).

Das Öffnen und Schließen des Bettes erfolgt durch leichten Zug am Regalboardgriff, dadurch schwingt das Bett inklusive Regalboard parallel zu Boden. Utensilien die sich auf dem Regalboard befinden müssen hierbei nicht entfernt werden (Foto 2).

## SOMIER CFg7

Este somier esta realizado en aluminio anodizado; la instalación del panel frontal se realiza sin herrajes.

El sistema mecánico de balanceo lleva un bloqueo de seguridad, sin tirantes, ni muelles a la vista, ya que está insertado en el marco con un sistema regulable (foto 1-2).

El marco esta integrado en la estructura de la unidad y desliza durante la apertura y cierre sobre levas de polizene. Los soportes y las uniones se realizan mediante moldes a medida y fusión (foto 3-4).

La apertura y cierre de la cama se realiza con simple gesto, con el tirador situado en el estante frontal, el cual, gracias a un movimiento basculante, se transforma en soporte de la cama sobre el suelo y como, durante el proceso de bajada se mantiene siempre paralelo al suelo, no se tienen que quitar los objetos situados sobre el estante (foto 2).



1



2



3



4



# Swing

design pierluigi colombo/ r&s clei  
patent pending

Divano con uno o due braccioli e con penisola scorrevole in 3 posizioni, con schienale reclinabile e con contenitore sotto la seduta.

Integrato con sistema componibile parete giorno si trasforma in letto matrimoniale sempre pronto e dispone di innovativa rete a doghe con telaio in alluminio e sistema di regolazione (rete CF97).

Sofa 281 cm wide with ending part that slides in three positions, with reclining back rest and storage underneath the seat. Integrated to a shelving element, it transforms into a double bed always ready to use provided with an innovative slatted bed base with aluminium frame (bed base CF97).

Canapé de largeur 281 cm, avec partie terminale coulissante en trois positions, avec dossier abaissable et coffre rangement sous l'assise. Intégré avec une paroi living, ce système se transforme en lit à 2 places toujours prêt avec sommier à lattes novateur avec encadrement en aluminium (sommier CF97).

Sofa 281 cm breit mit einem Eckteil welches eine Arm- und Rückenlehne beinhaltet (angebracht vor der Regalwand) vis a vis einen offenen Abschluss. Das Eckteil lässt sich in drei verschiedenen Relax Positionen einstellen. Dies erfolgt durch verschieben des Sitz- und Rückenteils. Die beiden Sofaelemente, die sich vor dem Klappbett befinden verfügen über einen Stauraum für Kissen etc. unterhalb der Sitzfläche. Das Bett besitzt einen innovativen Lattenrost eingebettet in einen Aluminiumrahmen (CF97).

Sofá de 281 cm de largo, con península terminal corredera en 3 posiciones, con respaldo reclinable y contenedor bajo el asiento. Integrado al modular de pared, se transforma en una cama de matrimonio lista para utilizar, con un somier de láminas con marco de aluminio innovador (CF97).

dimensioni

chiuso cm. L 281 + 18 (bracciolo) x P 35 (fianco) 125 x H 220

aperto cm. L 281 + 18 (bracciolo) x P 220 x H 220













# Atoll 202

design giulio manzoni/ pierluigi colombo/ r&s clei  
patent pending

Divano angolare con vano contenitore, integrato con sistema componibile parete giorno, trasformabile in letto matrimoniale sempre pronto, con innovativa rete a doghe con telaio in alluminio e sistema di regolazione (CF97).

Nella versione notte, l'elemento penisola del divano si ribalta per consentire l'accesso al letto.

Corner sofa provided with a storage space and integrated with a shelving element, it transforms into a double bed always ready to use provided with an innovative slatted bed base with aluminium frame (CF97).

In the night version, the "peninsula element" tips-up to have an easier access to the bed.

Canapé d'angle avec coffre rangement sous l'assise et intégré à une paroi modulaire living, il se transforme pour la nuit en lit à 2 places toujours prêt avec sommier à lattes novateur avec encadrement en aluminium (CF97). La meridienne du canapé est rabattable pour rendre plus facile l'accès au lit.

Klappbett mit einem Ecksofa. Unterhalb der Sitzfläche befindet sich ein Stauraum für Kissen etc. Mit einer seitlichen Regal-Paneelwand. Das integrierte Doppelklappbett verfügt über einen innovativen Lattenrost eingebettet in einen Aluminiumrahmen (CF97). Für die Nachtversion klappt man das Eck-Sofaelement einfach hoch, um einen leichteren Ein- und Ausstieg ins Bett zu ermöglichen.

Sofá de rincón con arcón en el modulo principal, integrado al modular de pared. Por la noche, se transforma en una cama de matrimonio con somier laminado lista para utilizar, con un somier de láminas con marco de aluminio innovador (CF97). El módulo "Peninsula" del sofá se levanta para acceder a la cama con más facilidad.

dimensioni con divano angolo p. 202

chiuso cm. L 281 x P 125/257 x H 220

aperto cm. L 281 x P 220/257 x H 220

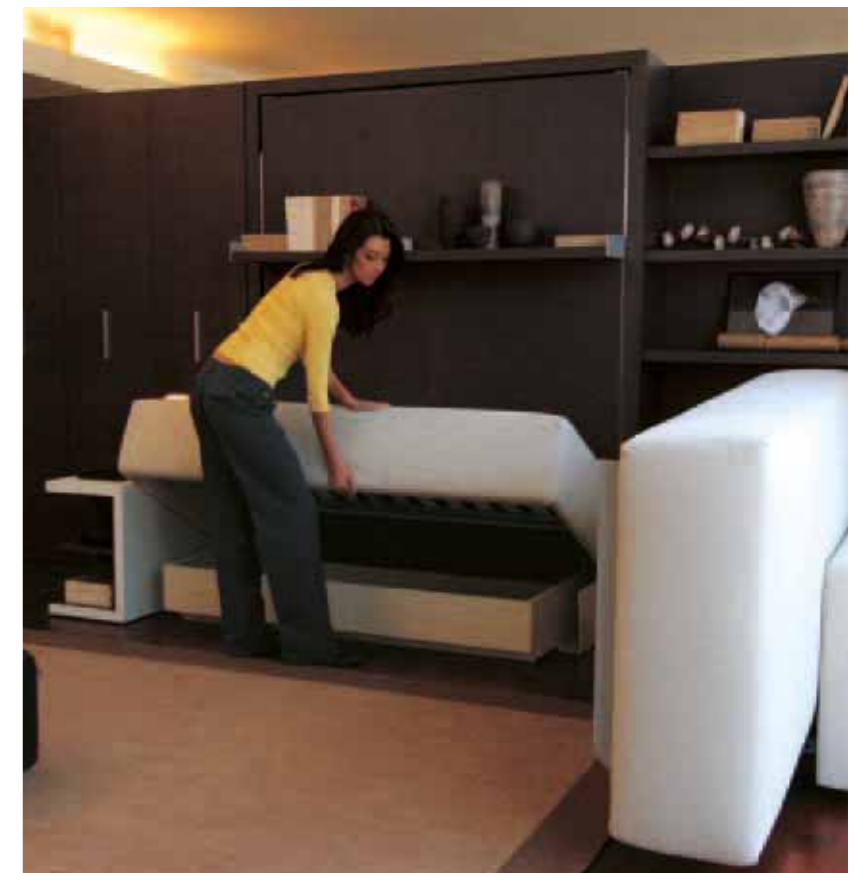



tojours  
tojours l'amour touje  
d'amour toujours l'am  
ours Toujours l'amour to  
ours l'amour toujours  
amour Toujours l'amou  
jours l'amour Toujou  
rs l'amour toujours l'  
tojours l'amour Touje

# Atoll 000

design giulio manzoni/ pierluigi colombo/ r&s clei  
patent pending

Divano largo 245 cm. con vano contenitore, integrato con sistema componibile parete giorno, trasformabile in letto matrimoniale sempre pronto, con innovativa rete a doghe con telaio in alluminio e sistema di regolazione (CF97).

Sofa 245 cm wide with a storage space underneath and integrated with a shelving element, it transforms into a double bed always ready to use provided with an innovative slatted bed base with aluminium frame (CF97).

Canapé de 245 cm de largeur avec coffre rangement sous l'assise et intégré à une paroi modulaire living, il se transforme pour la nuit en lit à 2 places toujours prêt avec sommier à lattes novateur avec encadrement en aluminium (CF97).

Klappbett mit einem Sofa 245 cm inklusiver einer Armlehne. Unterhalb der Sitzfläche befindet sich ein Stauraum für Kissen etc. Mit einer seitlichen Regal-Paneelwand. Das integrierte Doppelklappbett verfügt über einen innovativen Lattenrost eingebettet in einen Aluminiumrahmen (CF97).

Sofá de 245 cm con arcón contenedor, integrado al modular de pared. Se transforma en una cama de matrimonio lista para utilizar, con somier de láminas con marco de aluminio innovador (CF97).

## Dimensioni

Chiuso cm L 245 x P 125 x H 220

Aperto cm L 245 x P 220 x H 220



Nuovoliolà 10

Ito





# Nuovoliola' 10

design pierluigi colombo/ r&s clei  
patent pending

Sistema trasformabile con letto verticale ad apertura abbattibile e con divano e mensola libreria. Il divano dispone di un vano contenitore. Il mobile con un semplice movimento si trasforma in un letto matrimoniale pronto all'uso, dotato di una rete innovativa a doghe e con telaio in alluminio con sistema di regolazione (CFg7).

Transformable system with front sofa and bookshelf, through a mechanism and by an easy movement, it transforms into a double bed always ready to use provided with an innovative slatted bed base with aluminium frame (CFg7). The sofa is provided with a storage space underneath the seat.

Système transformable avec canapé et tablette bibliothèque, qui, grâce à un mécanisme articulé et par un simple geste, devient lit à 2 places toujours prêt avec sommier à lattes novateur avec encadrement en aluminium (CFg7). Sous le canapé on trouve un coffre rangement.

Verwandlungs-System mit einem integriertem Sofa und Regalboard. Durch einen speziellen Mechanismus und mit einfacher Bedienung verwandelt es sich in ein Doppelbett mit innovativen Lattenrost eingebettet in einem Aluminiumrahmen (CFg7). Unter der Sitzfläche befindet sich ein Stauraum.

Es un mueble vertical con sofá y estante librería que a través de un simple gesto y gracias a un mecanismo articulado, se transforma en una cama de matrimonio siempre lista para utilizar, con somier de láminas con marco de aluminio innovador (CFg7). El sofá tiene un arcón contenedor para almohadas.

## Dimensioni

chiuso cm. L 173 x P 35 (fianco) 121 x H 220

aperto cm. L 173 x P 220 x H 220

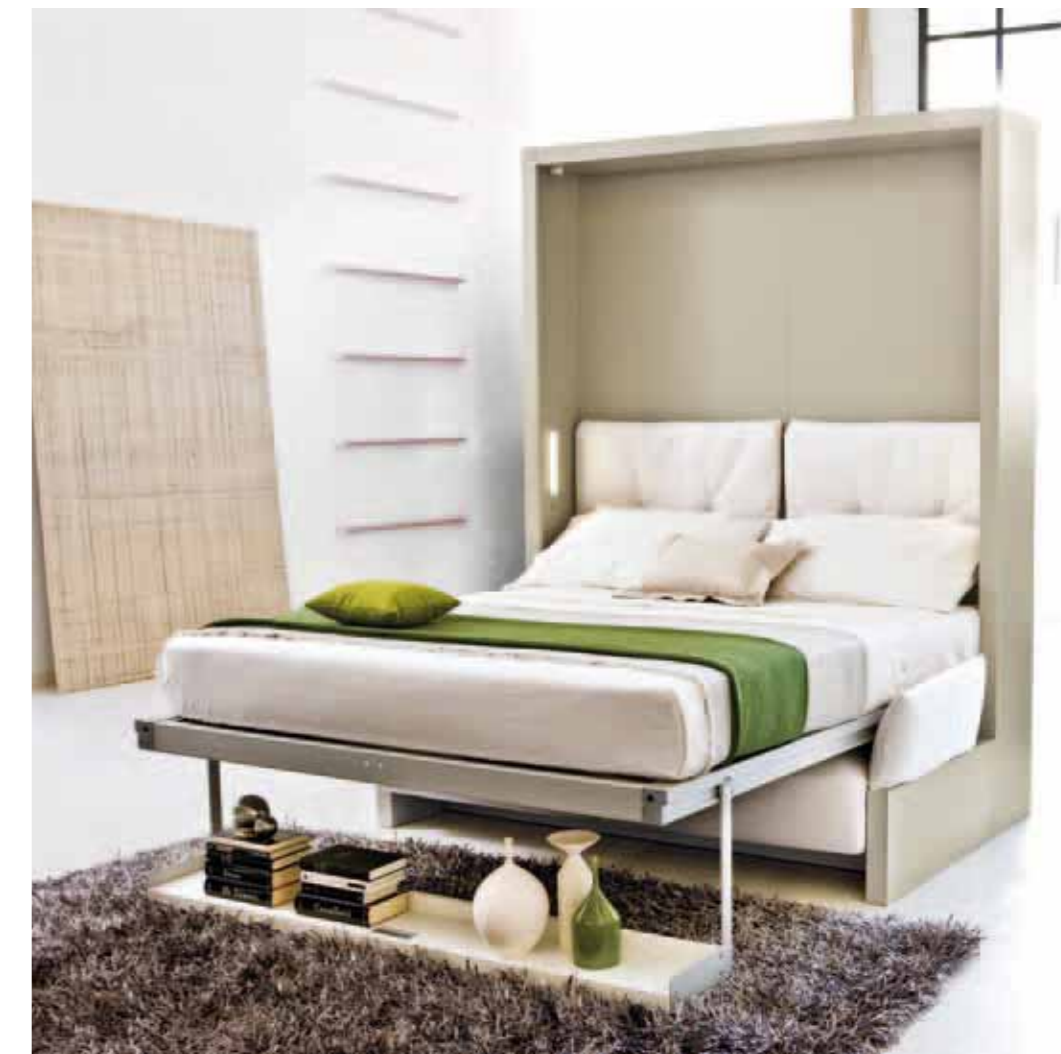









# Ito

design giulio manzoni / r&s clei  
patent pending

Sistema trasformabile composto da un letto matrimoniale verticale con apertura abbattibile pronto all'uso, dotato di una innovativa rete a doghe con telaio in alluminio con sistema di regolazione (CFg7) e da un comodo divano con seduta scorrevole e reclinabile e poggiatesta integrato.

Transformable system composed by a real double bed always ready to use provided with an innovative slatted bed base with aluminium frame (CFg7) and by a comfortable sofa with sliding seat, reclining backrest and integrated footrest.

Système transformable qui se compose d'un vrai lit à 2 places toujours prêt avec sommier à lattes novateur avec encadrement en aluminium (CFg7), et d'un canapé confortable prévu d'un système coulissant pour l'assise, d'un dossier abaissable et d'un repose-pied intégré.

Verwandlungs-System mit integriertem Relax-Sofa. Durch einfache Handhabung verwandelt sich dieses Modell schnell und einfach zum Doppelbett. Das Bett verfügt über einen innovativen Lattenrost eingebettet in einem Aluminiumrahmen (CFg7). Die Version besteht aus einem Relax-Sofa mit verschiebbarem Sitzteil und beweglichem Rückenteil. Die Fußstütze hebt sich nach oben.

Es un mueble vertical con sofá que lleva un apoyo piés extraíble, respaldo reclinable y estante librería que a través de un simple gesto y gracias a un mecanismo articulado, se transforma en una cama de matrimonio siempre lista para utilizar, con un somier de láminas con marco de aluminio innovador (CFg7).

## Dimensioni

chiuso cm. L 173 x P 35 (fianco) 121/174 x H 220

aperto cm. L 173 x P 220 x H 220







# Rete Cfo9

design r&s clei  
patent pending

## Rete Cfo9

Qualità e Innovazione. L'invenzione riguarda una rete con meccanismo di blocco automatico sia nella posizione verticale che orizzontale, che impedisce apertura-chiusura accidentali, con fissaggio della facciata di finitura senza necessità di ferramenta. Caratteristiche e vantaggi rispetto alle reti standard seriali:

- > La sicurezza è garantita dall'innovativo sistema di bloccaggio della rete mediante un perno che si innesta automaticamente (fig. 1)
- > Apertura e chiusura della rete si eseguono con un semplice movimento mediante il dispositivo inserito nel piede (fig. 2)
- > Il telaio e l'estetica della facciata sono frutto di tecnologie innovative: linee morbide con spessori importanti del manufatto con assenza di maniglie per non compromettere la pulizia estetica nella giunzione pannello/rete, con il meccanismo di apertura nascosto nelle fughe laterali (fig. 3-4).

## BED BASE Cfo9

Quality and innovation.

The innovation concerns a bed base with a self-locking mechanism both in the vertical than horizontal position, that avoids accidental opening-closing, and with a front panel to be fixed with no hardware. Features and advantages compared to the standard bed base:

- The safety is assured by the innovative locking system of the bed base through a pin that self-engages (photo 1).
- Opening and closing of the bed base by an easy movement through the device inserted in the foot (photo 2).
- the frame and the look of the front come from innovative engineering: soft lines, great thickness, no handles not to compromise the clear look of panel+bed base, opening mechanism hidden in the lateral gaps (photos 3-4).

## SOMMIER Cfo9

Qualité et Innovation.

L'invention concerne un sommier avec mécanisme de blocage automatique soit en position verticale que horizontale, qui empêche l'ouverture- fermeture accidentelles, et la fixation du panneau de façade sans l'aide de quincaillerie. Caractéristiques et avantages par rapport aux sommiers standards sériels:

- La sécurité est garantie par le système de blocage innovateur du sommier, par un goujon qui s'engage automatiquement (photo 1).
- L'ouverture et la fermeture du lit sont faites par un mouvement simple grâce à un dispositif inséré dans le pied (photo 2).
- L'encadrement et l'esthétique de la façade sont les résultats de technologies novatrices: lignes souples, épaisseurs importants du produit, aucune poignée pour ne pas compromettre la linéarité de la jonction panneau-sommier, mécanisme d'ouverture caché dans les espaces latéraux (photo 3-4).

## BED BASE Cfo9

Qualität und Innovation.

Die innovative Neuerung ist eine Selbstverriegelung für alle Betten mit vertikalen sowie horizontalen Öffnungsmechanismen welche ein versehentliches Öffnen bzw. Schließen des Frontpaneels inklusive Bett verhindert.

- Eigenschaften und Vorteile im Vergleich zu den Standardbetten:
- Die Sicherheit wird durch die innovative Verriegelung des Frontpneels mit dem stabilen Lattenrost durch einen Befestigungsstift automatisch selbst gesichert (siehe Foto 1).
  - Das Öffnen und Schließen des Bettes ist durch einfache Handhabung (durch ausschwenken der Bettfüße wird die Endriegelung betätigt) gegeben (siehe Foto 2).
  - Das Besondere an der innovativen Entwicklung ist, dass trotz des stabileren Rahmens die Anmutung des Bettes nicht verloren geht und in weichen Linien im Einklang steht (Foto 3-4).

## SOMIER Cfo9

Calidad e Innovación.

El invento consiste en, un somier con un mecanismo de bloqueo automático en posición vertical que impide la apertura / cierre accidental y la fijación del panel frontal sin herrajes.

- Características y ventajas en comparación con los somieres estandar :
- La seguridad esta garantizada por el sistema de bloqueo innovador del somier, gracias a un perno que se inserta automáticamente (foto 1).
  - La apertura y cierre de la cama se realizan con un movimiento simple, gracias al dispositivo insertado en el pie (foto 2).
  - El enmarcamiento y la estética del frente son el resultado de técnicas innovadoras: líneas ligeras, grosores importantes del producto, ningún tirador para no romper las líneas de unión panel /somier, mecanismo de apertura escondido en los espacios laterales (foto 3-4).



# Circe Sofa

design r&s clei / giulio manzoni  
patent pending

Sistema trasformabile con letto matrimoniale abbattibile ad apertura orizzontale, con rete a doghe innovativa e brevettata (CFo9) e divano in facciata che scompare all'apertura del letto e che rende il modello Circe Sofa autoportante.

Questo modello con profondità 35 può essere integrato nel programma Living.

Transformable system with tilting double bed opening horizontally, with an innovative and patented slatted bed base (CFo9). It is provided with a front sofa that disappears when the bed folds down and that makes Circe Sofa self-standing.

This model is 35 cm deep and it can be integrated in the CLEI Living System.

Système transformable avec lit à 2 places rabattable horizontalement avec sommier à lattes novateur avec encadrement en aluminium (CFo9). Il est prévu d'un canapé frontal qui se rabat pendant que le lit s'ouvre et qui fait Circe Sofa autoportante.

Ce modèle de profondeur 35 cm peut être également intégré dans le programme composable Clei Living.

Wandelbares System mit horizontalem Öffnungssystem. Das Bett verfügt über einen innovativen patentierter Lattenrost eingebettet in einem Aluminiumrahmen (CFo9) Beim Herunterklappen des Bettes platziert sich das Frontsofa unterhalb des Bettes. Das Grundmodell hat eine Tiefe von 35 cm und kann in die Systeme von CLEI Living integriert werden.

Circe Sofa es un sistema transformable con cama de matrimonio abatible con apertura horizontal, siempre lista para utilizar y con un somier de láminas con marco de aluminio innovador y patentado (CFo9). El sofa se oculta cuando baja la cama y que no necesita fijación a pared. Este modelo de 35 cm de profundidad se puede integrar en el programa CLEI "living".

dimensioni

chiuso cm. L 216 x P 35 (fianco) 122,5 x H 220

aperto cm. L 216 x P 161,2 x H 220



# Penelope Sofa

design r&s clei/ giulio manzoni  
patent pending

Sistema trasformabile con letto matrimoniale verticale con apertura abbattibile, con rete a doghe innovativa e brevettata (CFo9) e divano in facciata che scompare all'apertura del letto e che rende il modello Penelope Sofa autoportante.

Questo modello con profondità 35 può essere integrato nel programma Living.

Transformable system with tilting double bed opening vertically, with a innovative and patented slatted bed base (CFo9) and a front sofa that disappears when the bed folds down and that makes model Penelope Sofa self-standing.

This model is 35 cm deep and it can be integrated in the CLEI Living System.

Système transformable avec lit à 2 places rabattable verticalement avec sommier à lattes novateur avec encadrement en aluminium (CFo9) et canapé frontale qui se rabat pendant que le lit s'ouvre et qui permet au modèle Penelope Sofa d'être autoportante.

Ce modèle de profondeur 35 cm peut être également intégré dans le programme composable Clei Living.

Verwandlungsmodell mit vertikalem Öffnungssystem. Das Bett verfügt über einen innovativen patentierten Lattenrost eingebettet in einem Aluminiumrahmen (CFo9). Im Modell integriert ist ein Sofa, welches beim Herunterklappen des Bettes sich unterhalb des Bettes platziert. Das Grundmodell hat eine Tiefe von 35 cm und kann in die Systeme von CLEI Living integriert werden.

Sistema trasformabile con cama de matrimonio abatible verticalmente, siempre lista para utilizar y con un somier de láminas con marco de aluminio innovador y patentado (CFo9). Con sofa que se oculta cuando baja la cama y no necesita fijación a pared. Este modelo de 35 cm de profundidad, se puede integrar en el programa CLEI "living".

dimensioni

chiuso cm. L 167 x P 35 (fianco) 122,5 (sofà) x H 220

aperto cm. L 167 x P 213,9 x H 220







# Doc.

design giulio manzoni  
patent pending

DOC. è un comodo divano completamente sfoderabile che con un semplice gesto e senza sforzo si trasforma in un pratico letto a castello, dotato di una sicura scala integrata nella struttura, che funge anche da sostegno e da barriera protettiva.

DOC. is a comfortable sofa with fully removable covering, that with a simple movement and no strain becomes a practical bunk bed, provided with a safe ladder integrated in the structure which is also a support and a protective barrier.

DOC. est un confortable canapé entièrement déhoussable qui par un simple mouvement d'ouverture et sans aucun effort physique se transforme en deux lits superposés. Il est doté d'une échelle intégrée dans sa structure, qui est aussi support et barrière de protection.

DOC. ist ein komfortables Sofa mit komplett abnehmbaren Bezügen. Mit einfachster Bedienung und ohne Anstrengung wird es zum praktischen Etagenbett. Ausgestattet mit einer sicheren und integrierten Leiter, die vorne am Bettrahmen befestigt ist und gleichzeitig eine schützende Barriere bildet.

El sistema transformable DOC. es un cómodo sofá completamente desenfundable que con un simple gesto y sin esfuerzo físico se transforma en una práctica litera, dotado de una segura escalera integrada en la estructura, que también tiene la función de soporte y de barrera de protección.

dimensioni

chiuso cm. L 206 x P 90 H 95

aperto cm. L 206 x P 90 x H 139

barriera scala H. 149



# Doc. XL

design giulio manzoni  
patent pending

DOC.XL è un comodo divano completamente sfoderabile che con un semplice gesto e senza sforzo si trasforma in un pratico letto a castello, dotato di una sicura scala integrata nella struttura, che funge anche da sostegno e da barriera protettiva.

DOC.XL is a comfortable sofa with fully removable covering, that with a simple movement and no strain becomes a practical bunk bed, provided with a safe ladder integrated in the structure which is also a support and a protective barrier.

DOC.XL est un confortable canapé entièrement déhoussable qui par un simple mouvement d'ouverture et sans aucun effort physique se transforme en deux lits superposés. Il est doté d'une échelle intégrée dans sa structure, qui est aussi support et barrière de protection.

DOC.XL ist ein komfortables Sofa mit komplett abnehmbaren Bezügen. Mit einfachster Bedienung und ohne Anstrengung wird es zum praktischen Etagenbett. Ausgestattet mit einer sicheren und integrierten Leiter, die vorne am Bettrahmen befestigt ist und gleichzeitig eine schützende Barriere bildet.

El sistema transformable DOC.XL es un cómodo sofá completamente desenfundable que con un simple gesto y sin esfuerzo físico se transforma en una práctica litera, dotado de una segura escalera integrada en la estructura, que también tiene la función de soporte y de barrera de protección.

dimensioni

chiuso cm. L 245 x P 88 H 72

aperto cm. L 245 x P 88 x H 138

barriera scala H. 147





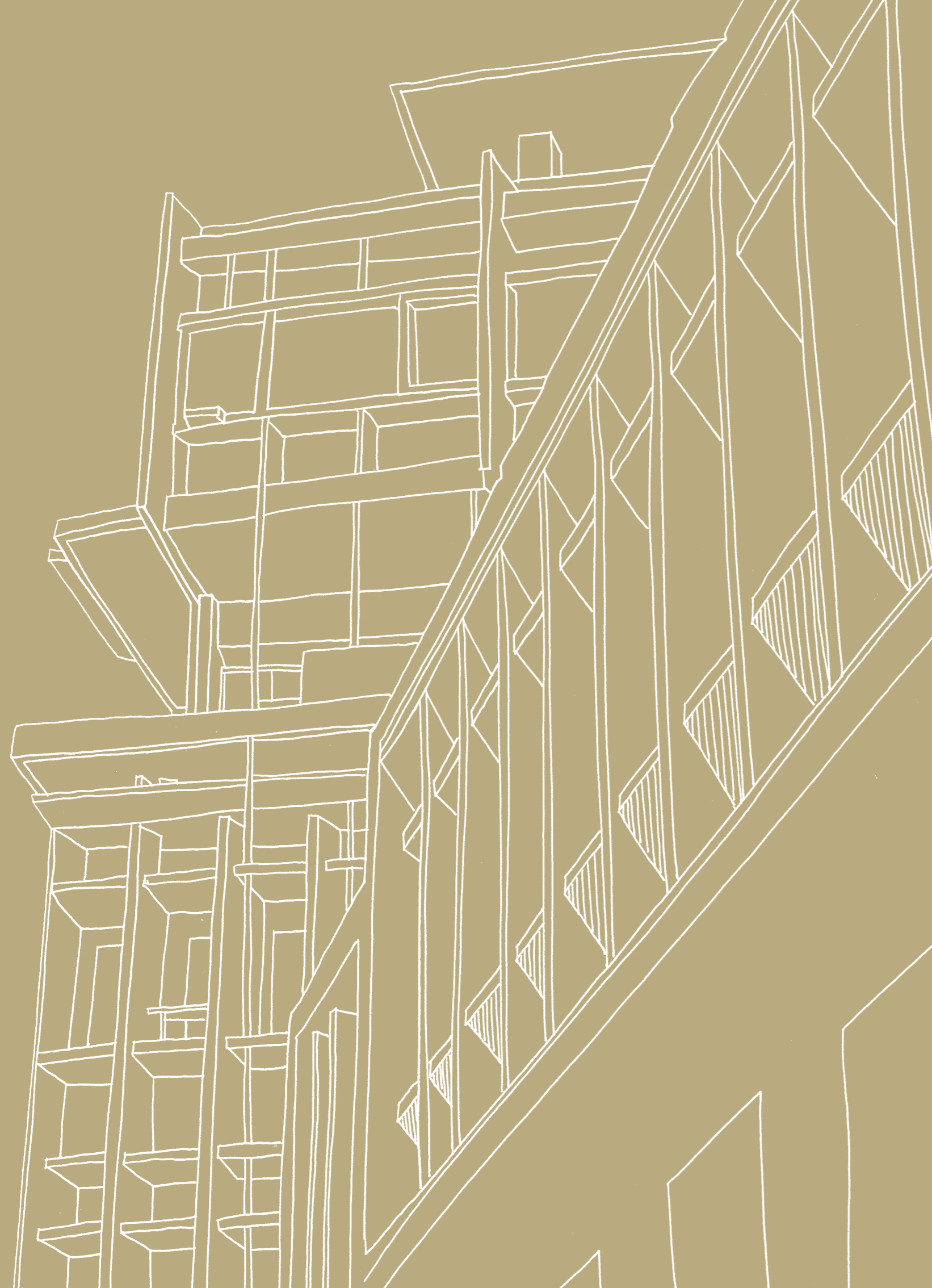

Lgm 02

Lgm 01

Lgm



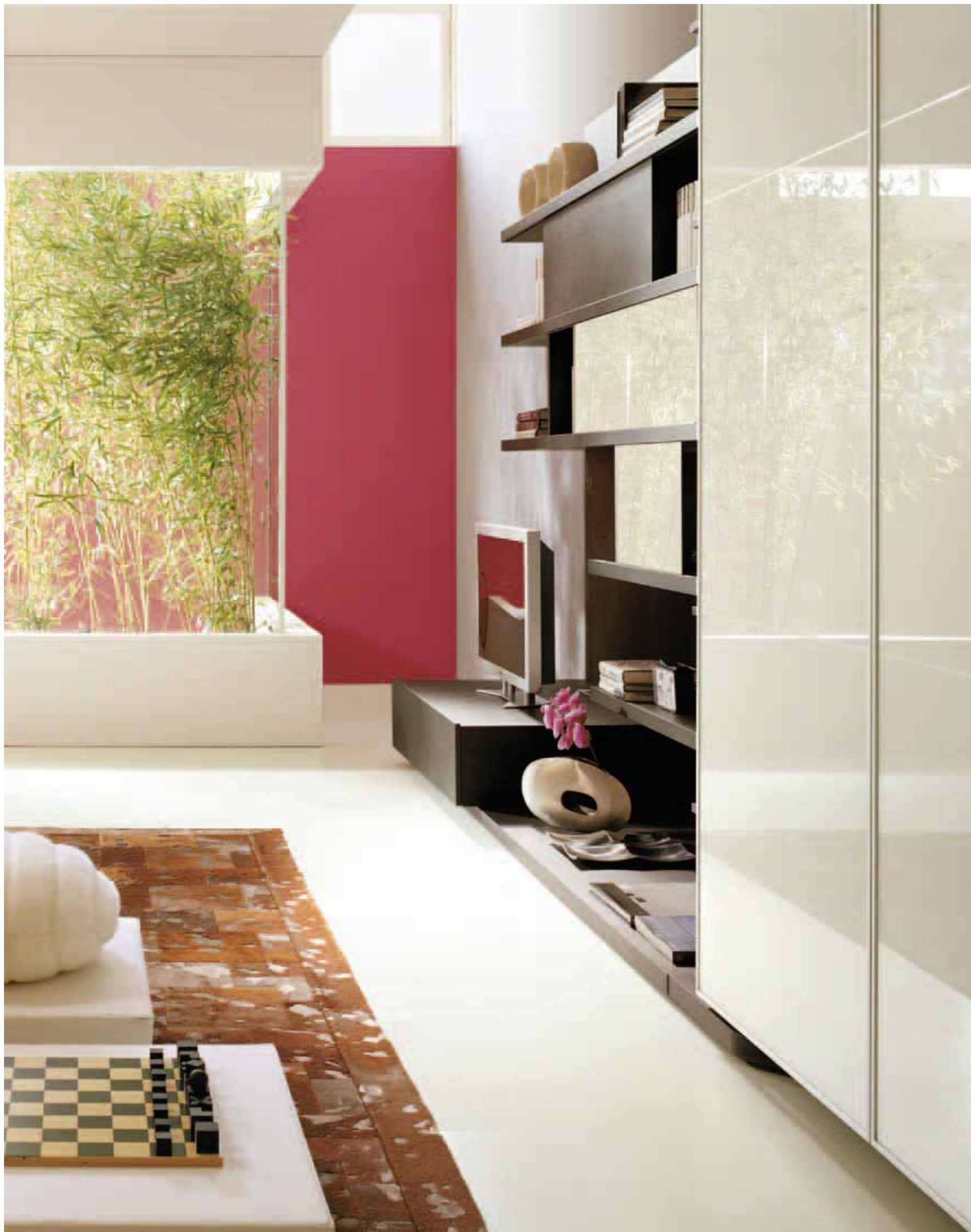

# Lgm 02

design r&s clei/ pierluigi colombo  
patent pending

Mobile a doppia funzione, si trasforma attraverso un movimento rotatorio nella versione notte in un letto sempre pronto con rete a doghe e piani comodino laterali estraibili.

Double-use wall unit that, through a turning mechanism transforms from day to night version into a double bed always ready to use with wooden slatted bed base and lateral sliding tablets for the night.

Meuble paroi à double fonction qui, grâce à un mécanisme rotatoire se transforme en version nuit en lit à 2 places toujours prêt avec sommier à lattes en bois et petites tables de nuits latérales coulissantes.

Das umwandelbare System LGM ist ein Doppelfunktions-Möbelsystem für Tag- und Nachtversionen. Durch eine vertikale Drehbewegung wird es ein jederzeit zum Schlafen geeignetes Doppelbett. Ausgestattet mit einem innovativen Holzlattenrost und seitlichen ausziehbaren Nachttischchen.

Mueble que en su versión día está disponible con estantes librería y puertas. Y a través de un movimiento rotatorio se transforma en la versión noche, en una cama de matrimonio siempre lista para utilizar, con somier de láminas y dos estantes / mesitas laterales extraíbles.

## Dimensioni

chiuso cm. L 184,2 x P 62,3 x H 220

aperto cm. L 184,2 x P 243 x H 220











# Lgm 01

design r&s clei/ pierluigi colombo  
patent pending

Mobile a doppia funzione personalizzabile nella versione giorno con ampio tavolo basculante, si trasforma attraverso un movimento rotatorio nella versione notte con letto sempre pronto con rete a doghe.

LGM 01 is a double-use wall unit with a front wide tilting table. Through a turning mechanism it transforms to the night version into a double bed ready to use with wooden slatted bed base.

LGM 01 est un meuble à double fonction avec grande table frontale abattante. Grâce à un mécanisme rotatoire il se transforme en version nuit en un lit à 2 places toujours prêt avec sommier à lattes en bois.

LGM 01 beinhaltet eine doppelte Verwendung, Schrankwand mit einem breiten schwenkbaren Tisch. Durch einen Drehmechanismus verwandelt es sich von einer Tag- in eine Nachtversion. Das Bette verfügt über einen innovativen Holz-Lattenrost.

Mueble a dos funciones con una amplia mesa basculante, que en la versión noche y con un simple movimiento giratorio se transforma en una cama de matrimonio, siempre lista para utilizar, con somier de láminas de madera.

dimensioni

chiuso cm. L 184,2 x P 62,3 x H 220

aperto cm. L 184,2 x P 243 x H 220

tavolo L. 158,8 P.66,8





# Lgm

design r&s clei/ pierluigi colombo  
patent pending

Mobile a doppia funzione personalizzabile nella versione giorno con differenti elementi estetico/funzionali, si trasforma attraverso un movimento rotatorio nella versione notte in un letto sempre pronto con rete a doghe e piani comodino laterali estraibili.

Double-use wall unit available with different kind of frontal features, through a turning mechanism it transforms from day to night version into a double bed always ready to use with wooden slatted bed base and lateral sliding tablets for the night.

Meubles paroi à double fonction disponible avec différentes façades, grâce à un mécanisme rotatoire se transforme en version nuit en lit à 2 places toujours prêt avec sommier à lattes en bois et petites tables de nuits latérales coulissantes.

Das umwandelbare System LGM ist ein Doppelfunktions-Möbelsystem für Tag- und Nachtversionen, mit verschiedenen Frontmöglichkeiten. Durch eine vertikale Drehbewegung wird es ein jederzeit zum Schlafen geeignetes Doppelbett. Ausgestattet mit einem innovativen Holzlattenrost und seitlichen ausziehbaren Nachttischchen.

Mueble que en su versión día está disponible con estantes librería y puertas de cristal o madera (según versión seleccionada). Y a través de un movimiento rotatorio se transforma en la versión noche, en una cama de matrimonio siempre lista para utilizar, con somier de láminas y dos estantes / mesitas laterales extraíbles.

## Dimensioni

chiuso cm. L 184,2 x P 62,3 x H 220

aperto cm. L 184,2 x P 243 x H 220



Poppi Theatre

Poppi Book





# Poppi Theatre

design r&s clei/ pierluigi colombo  
patent pending

Sistema trasformabile composto da un letto singolo a scomparsa con rete a doghe e libreria laterale, dotato di un pannello scorrevole cablato porta tv plasma /LCD, che consente nelle sue fasi di movimento di mantenere i cavi sempre nascosti. Il sistema è integrabile con la componibilità del programma clei living.

Transformable system composed by a tilting single bed with slatted bed base and a beside bookshelf, provided with a sliding cabled panel for TV display /LCD, where cables remain always hidden during its movement. This system can be integrated in the CLEI Living System.

Système transformable qui se compose d'un lit à 1 place rabattable avec sommier à lattes et d'une bibliothèque latérale, prévu d'un panneau coulissant câblé porte TV /LCD, où les câbles restent toujours cachés pendant les mouvements.

Dieses Verwandlungsmodell ist zusammengesetzt aus einem Einzelklappbett mit innovativen Holzlattenrost. Seitlich Bücherregale und ein Schiebepaneel für LCD-TV. Die LCD-Kabel sind auch bei der Bewegung des Schiebepaneels nicht sichtbar. Das Modell kann mit den Elementen aus CLEI Living kombiniert werden.

Sistema transformable que se compone de una cama individual abatible horizontalmente con somier de láminas y librería lateral, previsto de un panel corredero cableado para TV PLASMA /LCD, que consigue durante el movimiento mantener los cables ocultos. El sistema se puede integrar en el programa Living.

dimensioni

chiuso cm. L 336 x P 74,4 x H 141,3

aperto cm. L 336 x P 102 x H 141,3





# Poppi Book

design r&s clei  
patent pending

Sistema trasformabile composto da un letto a scomparsa sempre pronto con rete a doghe e da una capiente libreria.

Transformable system composed by a roomy bookcase and a tilting single bed .

Système transformable composé d'une grande bibliothèque et d'un lit à 1 place rabattable.

Das wandelbare Einzelklappbett mit einem Bücherregal kann jederzeit zum Schlafen benutzt werden.

Sistema transformable formado por una cama individual abatible horizontalmente y una librería en la parte superior.

## Dimensioni

Chiuso cm 216 x P 31 x H 220

Aperto cm 216 x P 100,5 x H 220





Cabrio In

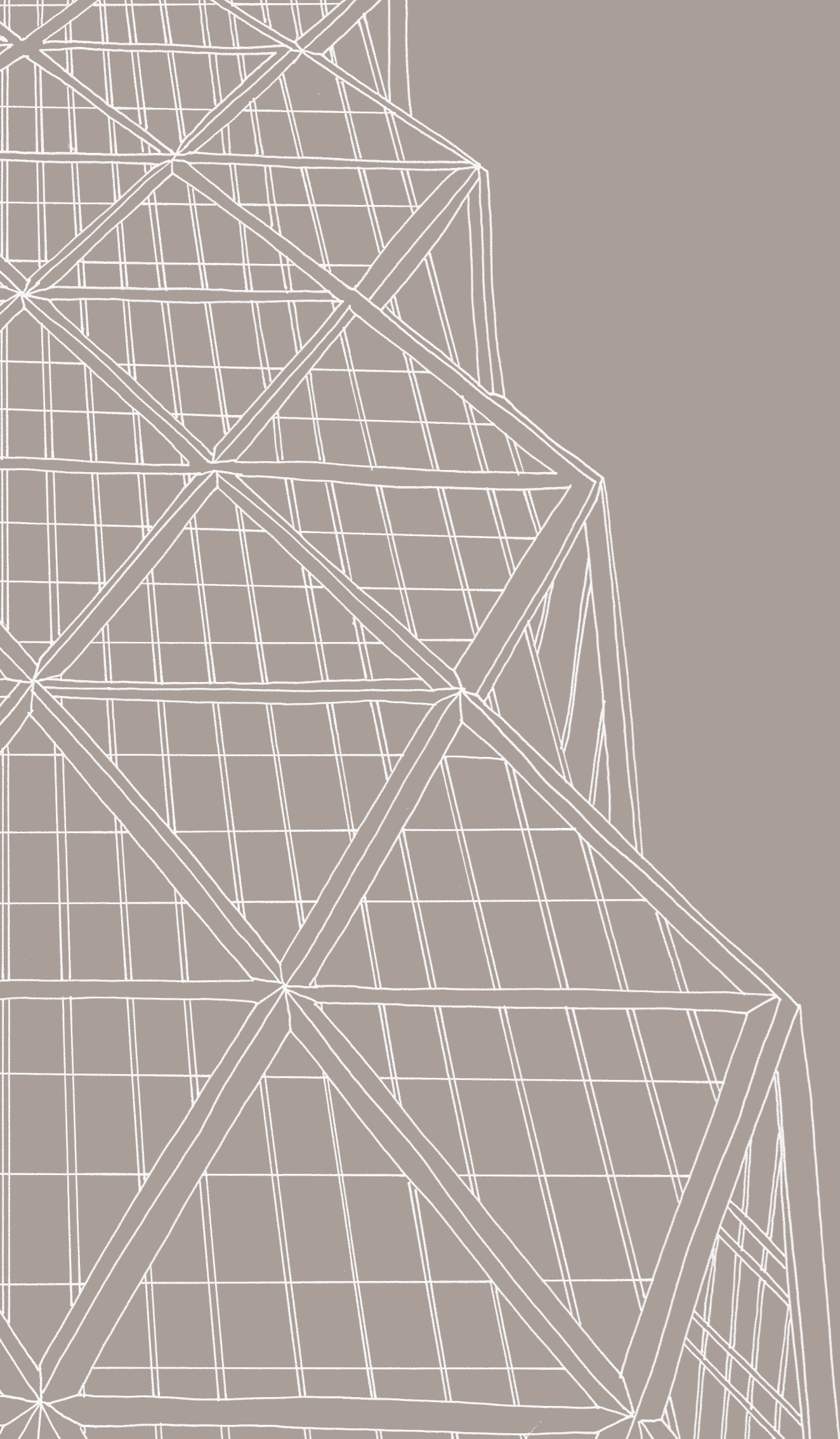



# Cabrio In

design giulio manzoni / pierluigi colombo  
patent pending

Sistema trasformabile per zona studio/lavoro integrabile nei programmi componibili Young&Living. Il sistema coniuga uno scrittoio elevabile di grandi dimensioni con un letto singolo. Con un semplice movimento si trasforma nella versione notte senza dover rimuovere nulla dal piano scrittoio.

Transformable system for working area, independent or integrated in other elements of CLEI furniture collection. This model is composed by a wide desk and a single tilting bed, and it transforms from day to night version without displacing anything on the desk top.

Système transformable pour l'espace bureau, indépendant ou intégrable au programme d'ameublement CLEI. Il se compose d'un large plan bureau et d'un lit à 1 place, qui, par un simple mouvement se transforme en version jour/nuite sans débarrasser le plateau de travail.

Ein wandelbares System mit Arbeitsplatz fürs Studium oder Lernen. Das Modell kann entweder solitär oder eingebettet zwischen verschiedenen Schrankmodulen stehen. Dieses System kombiniert einen großen Schreibtisch mit einem ausklappbaren Einzelbett. Mit einer einfachen Handhabung ändert sich das Bett von der Tag- in die Nachtversion, ohne dass man jegliches loses Büroequipment von der Schreibtischplatte entfernen muss.

Sistema transformable, para el area de estudio y trabajo, solo o integrado en el programa componible. El sistema esta formado por un gran tablero escritorio y una cama individual. Con un simple movimiento se transforma en las versiones dia y noche, sin tener que quitar nada del tablero escritorio.

Dimensioni (senza mobili o spalle)  
chiuso cm. L 216 x P 87,7 (scrittoio) x H 102,3  
aperto cm. L 216 x P 105,5 x H 128,2





Ulisse Dining

Ulisse Desk

Home Office



中 恩 太 握 扉 頭 假

# Ulisse Dining

design giulio manzoni/ r&s clei  
patent pending

Sistema trasformabile composto da un letto matrimoniale verticale con apertura abbattibile, con rete a doghe, caratterizzato nella versione giorno da un tavolo che scompare, traslando contestualmente all'apertura del letto e che si posiziona sotto la rete.

Tilting double bed with vertically opening, with slatted bed base. In the day configuration it is provided with a front table that disappears while the bed opens, sliding and remaining located underneath the bed base.

Lit à 2 places rabattable à ouverture verticale avec sommier à lattes; en version jour il est prévu d'une table frontale qui disparaît, parce qu'elle coulisse quand le lit s'ouvre et reste placée au dessous du sommier.

Doppelklappbett mit vertikalem Öffnungssystem inklusive eines innovativen Holzlattenrostes und einer Tischanbringung am Frontpaneel. Der Tisch wird beim Öffnen des Bettes zusammengeklappt und befindet sich somit unterhalb des geöffneten Bettes.

Cama de matrimonio abatible de apertura vertical, con somier de láminas. En la versión día tiene un mesa frontal que desaparece cuando la cama se abre y se mantiene debajo del somier.

dimensioni

chiuso cm. L 167 x P 166,5 x H 220

aperto cm. L 167 x P 214,2 x H 220









# Ulisse Desk

design giulio manzoni/ r&s clei  
patent pending

Sistema trasformabile con letto abbattibile verticale sempre pronto e tavolo in facciata che scompare all'apertura del letto.

Disponibile anche nella versione letto singolo (Telemaco Desk) Questo modello con profondità 31 può essere integrato nel programma LIVING.

Transformable system with vertical tilting double bed ready to use, provided with a front table that disappears while the bed folds down. It is available as well with single bed (Telemaco Desk). Both of the versions, 31 cm deep, can be integrated in LIVING Clei program.

Système transformable avec lit à 2 places rabattable verticalement toujours prêt, avec table frontale qui se rabat pendant que le lit s'ouvre. Ce modèle est disponible même en version à 1 place (Telemaco Desk). Les deux, de profondeur 31cm, peuvent être également intégrés au programme composable Clei Living.

Doppelklappbett mit vertikalem Öffnungssystem und einer Tischanbringung am Frontpaneel. Es verfügt über einen innovativen Holzlattenrost. Der Tisch wird beim Öffnen des Bettes zusammengeklappt und befindet sich somit unterhalb des geöffneten Bettes. Dieses Modell ist auch als Einzelklappbett unter der Modellbezeichnung Telemaco Desk erhältlich. Beide Versionen haben eine Tiefe von 31 cm und können mit den Elementen aus dem CLEI LIVING Programm kombiniert werden.

Ulisse Desk es un sistema transformable con cama de matrimonio abatible verticalmente siempre lista para utilizar con somier de láminas y mesa escritorio que se oculta cuando la cama baja. También esta disponible para cama individual (Telemaco Desk). Las dos versiones pueden ser integradas en el programa de Clei "living" de profundidad 31cm.

dimensioni

aperto cm. L 167 x P 214,2 x H 220

chiuso cm. L 167 x P 31 (fianco) 92 (scrittoio) x H 220



# Home Office

design giulio manzoni  
patent pending

Colonna armadio attrezzata da postazione lavoro per PC.  
Le ante inferiori contengono uno spazio dedicato all'alloggio della Tower, l'anta centrale con apertura a ribalta si trasforma in un piano scrittoio.

Storage unit equipped as computer working station.  
The lower doors hide the space reserved to the tower, while the middle tilting door becomes a writing desk.

Colonne armoire équipée pour travailler avec PC.  
Les portes inférieures cachent un espace réservé à la Tower, et la porte centrale avec ouverture rabattable devient le plan d'écriture.

Einheit als Computerarbeitsplatz ausgerüstet. Hinter den unteren Türen gibt es Platz für einen PC inklusive Verkabelung. Die Mitteltüre mit Klappöffnung wird zum Schreibtisch.

Column armario equipada para poder trabajar con el ordenador.  
Las puertas inferiores esconden el espacio reservado para la CPU y la puerta central abatible se transforma en la tapa de mesa.

dimensioni  
L 108 x P 35/105,5 (scrittoio aperto) x H 220



Poppi Sd 90/120

Poppi Desk 90/120







# Poppi Sd 90/120

design pierluigi colombo / giulio manzoni  
patent pending

Sistema trasformabile con letto singolo orizzontale con apertura abbattibile con rete a doghe ed integrato con un piano scrittoio fisso ed elemento attrezzato scorrevole porta PC ed accessori.

Il letto è dotato di testata imbottita reclinabile.

System composed by a single bed, a fix desk and a sliding element equipped for PC.

Système transformable qui se compose d'un lit à 1 place rabattable, d'un plan bureau fixe et d'un élément coulissant équipé pour PC et ses accessoires.

Das System beinhaltet ein Einzelklappbett, wählbar in zwei Größen mit einem fest installierten Schreibtisch und einer Schiebeeinrichtung für PC-Station.

Sistema transformable formado por una cama individual ocultable y tablero escritorio fijo, con mueble corredero equipado, porta PC y elementos de soporte.

dimensioni SD 90

chiuso cm. L 216 (letto) + 90/108/126/144 (desk) x P 84 x H 102,3

aperto cm. L 216 (letto) + 90/108/126/144 (desk) x P 102 x H 102,3

dimensioni SD 120

chiuso cm. L 216 (letto) + 90/108/126/144 (desk) x P 84 x H 126,8

aperto cm. L 216 (letto) + 90/108/126/144 (desk) x P 124,8 x H 126,8





# Poppi Desk 90/120

design r&s clei  
patent pending

Sistema trasformabile composto da un letto a scomparsa sempre pronto con rete a doghe e da un piano scrittoio/tavolo a ribalta.

Disponibile con letto singolo (Poppi 90) ed intermedio (Poppi 120) anche nella versione senza tavolo.

Transformable system composed by a tilting bed always ready to use with slatted bed base, and a tilting table. This model is available either with single bed (Poppi 90) or with intermediate bed (Poppi 120), also with no table.

Système transformable composé d'un lit rabattable toujours prêt avec sommier à lattes et d'une table abatante. Ce modèle est disponible avec lit à 1 place (Poppi 90) ou 1 place et demie (Poppi 120), même sans table.

Das wandelbare Einzelklappbett ist in zwei Größen erhältlich (Einzelklappbett Poppi 90 und Zwischengröße Poppi 120) es kann jederzeit zum Schlafen benutzt werden. Ferner kann man an jedes Bett einen klappbaren Arbeitsplatz installieren.

Sistema transformable formado por una cama individual abatible horizontalmente siempre lista para utilizar con somier de láminas y con mesa escritorio abatible opcional. Disponible en cama individual (Poppi 90) o cama de cuerpo y medio (Poppi 120).

dimensioni 90

chiuso cm. L 216 x P 31 x H 102,3

aperto cm. L 216 x P 100,5 x H 102,3

dimensioni 120

chiuso cm. L 216 x P 31 x H 126,8

aperto cm. L 216 x P 124,8 x H 126,8

scrittoio 170 x 66,3





Penelope

Lollisoft In





# Penelope

design r&s clei  
patent pending

Sistema trasformabile con letto matrimoniale verticale con apertura abbattibile, con rete a doghe innovativa e brevettata (CFo9).

Questo modello con profondità 35 può essere integrato nel programma Living. Disponibile con letto singolo (Altea 90) ed intermedio (Altea 120).

Transformable system with tilting double bed opening vertically, with a innovative and patented slatted bed base (CFo9). This model is 35 cm deep and it can be integrated in the CLEI Living System. It is available either with single bed (Altea 90) or with intermediate bed (Altea 120).

Système transformable avec lit à 2 places rabattable verticalement avec sommier à lattes novateur avec encadrement en aluminium (CFo9).

Ce modèle de profondeur 35 cm peut être également intégré dans le programme composable Clei Living. Il est disponible aussi avec lit à 1 place (Altea 90) ou à 1 place et demie (Altea 120).

Doppelklappbett mit vertikalem Öffnungssystem. Das Bett verfügt über einen innovativen patentierten Lattenrost eingebettet in einem Aluminiumrahmen (CFo9). Das Modell hat eine Tiefe von 35 cm und kann in die Systeme von CLEI Living integriert werden. Es kann wahlweise mit einem Einzelbett (Altea 90) oder einer Zwischenbreite von 120 cm (Altea 120) kombiniert werden.

Sistema transformable con cama de matrimonio abatible verticalmente, siempre lista para utilizar y con somier de láminas, innovador y patentado (CFo9). También esta disponible para cama individual (Altea 90) o cama de cuerpo y medio (Altea 120). Las dos versiones pueden ser integradas en el programa de Clei "living" de profundidad 35cm.

dimensioni

chiuso cm. L 167 x P 35 x H 220

aperto cm. L 167 x P 213,9 x H 220



# Lollisoft In

design giulio manzoni/ r&s clei  
patent pending

Sistema letto a castello trasformabile con scaletta autonoma removibile. Il letto superiore è dotato di barriera protettiva imbottita e dispone di un meccanismo di articolazione per facilitare il rifacimento del letto.

Transformable bunk bed system with loose ladder, and upper bed provided with an innovative upholstered safety barrier and a special device that helps making the bed.

Système lits superposés transformable, avec échelle amovible et lit supérieur prévu d'une novatrice barrière de sécurité rembourrée et d'un dispositif spécial pour aider à refaire le lit.

Klappbares Stockbett mit lose leiter und einer speziellen Neigetechnik (zum leichteren Leintuch-Tagesdecken-wechsel) und einem innovativen umlaufenden gepolsterten, abklappbaren Betthaupt.

Sistema transformable con dos camas literas abatibles, con escalera separada y una barrera superior de seguridad nueva y acolchada y un dispositivo especial para ayudar a hacer la cama superior.

dimensioni H.194,3  
chiuso cm. L 216 x P 31 x H 194,3  
aperto cm. L 216 x P 100,5/103,3 (letto superiore con scala) x H 194,3

dimensioni H. 220  
chiuso cm. L 216 x P 31 x H 220  
aperto cm. L 216 x P 100,5/103,3 (letto superiore con scala) x H 220





HOLIDAY o1

Lgm o1

Doc.

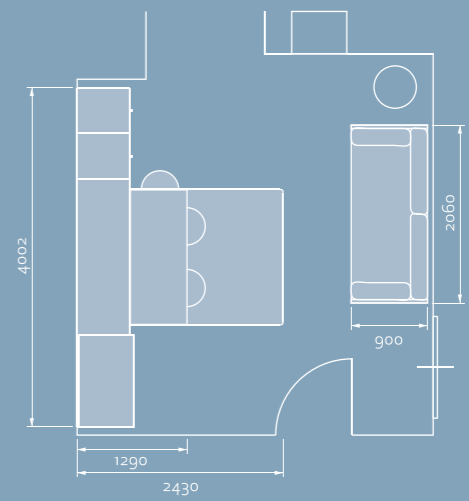
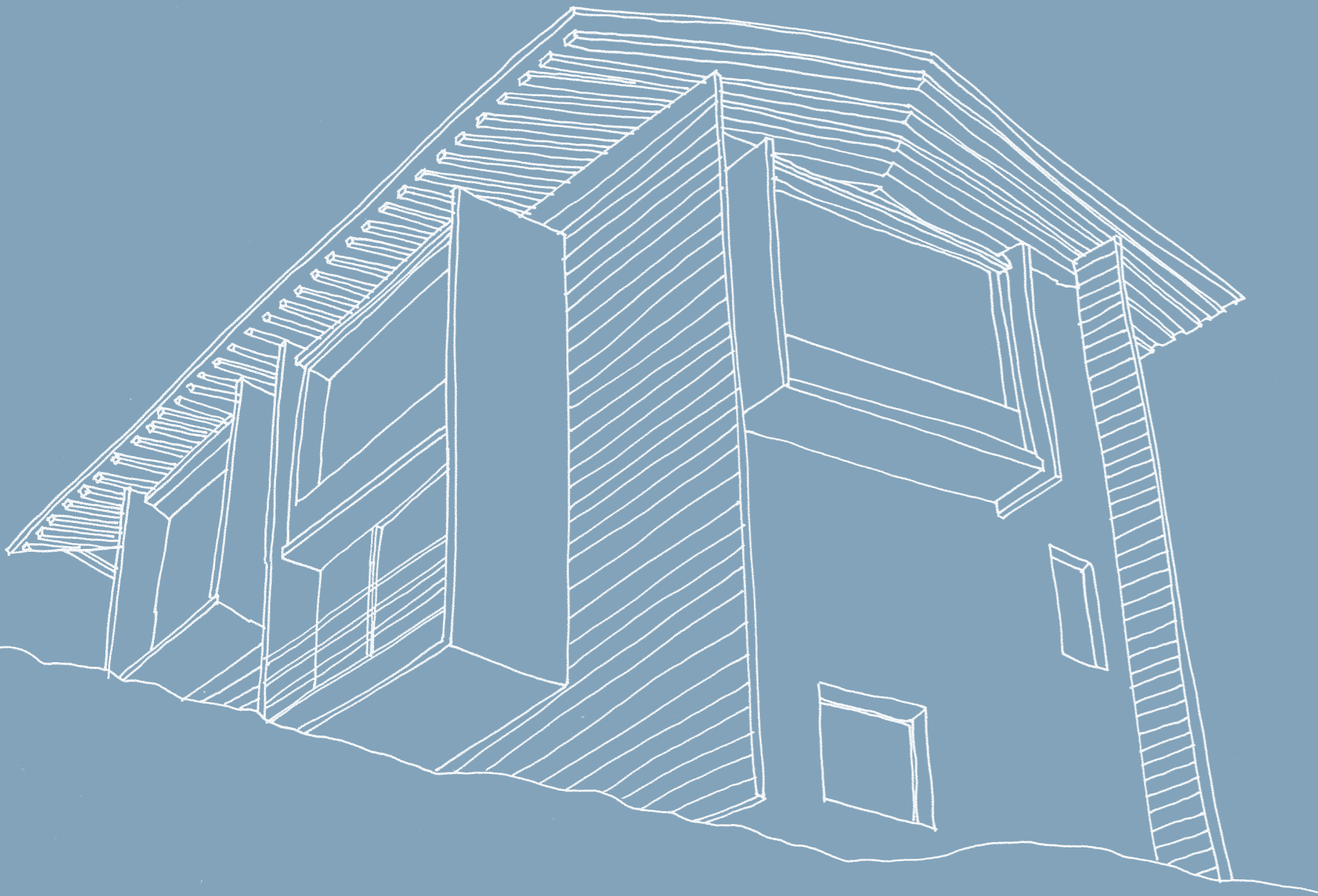









HOLIDAY 02

Penelope Sofa

Lollisoft In

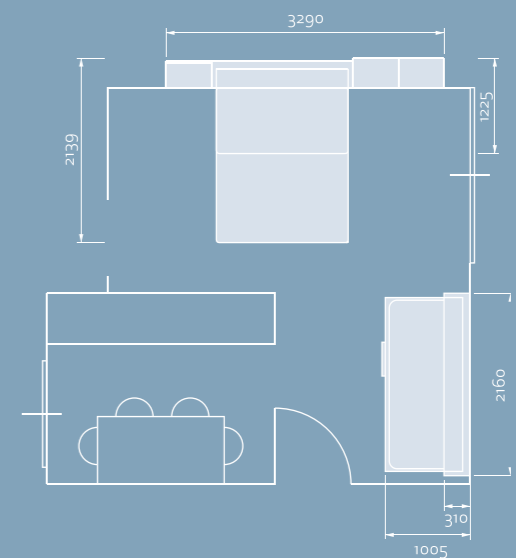







## Atoll 202

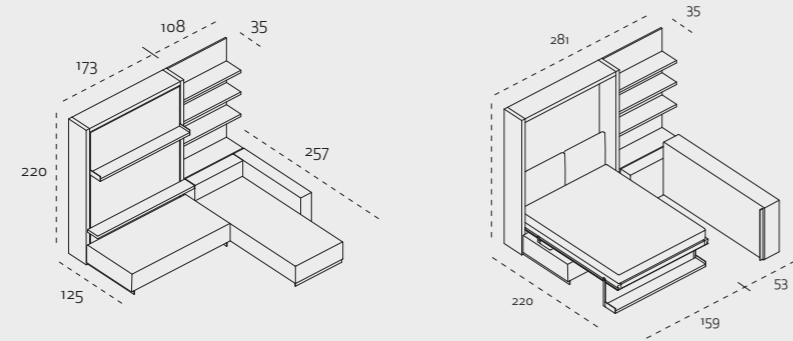

## Nuovo Liola' 10

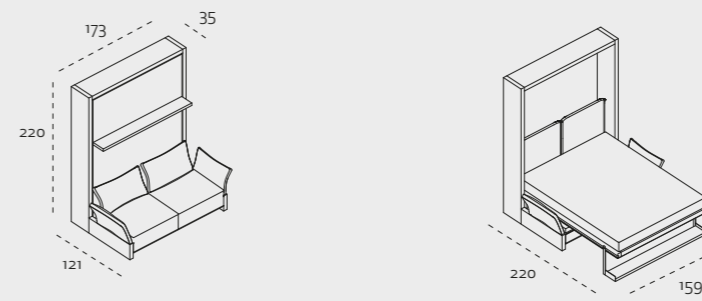

## Atoll 000

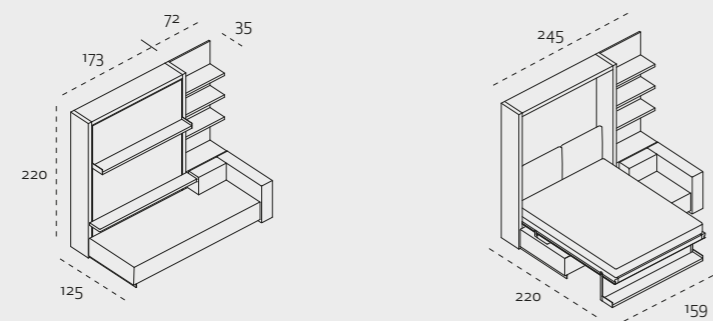

## Ito

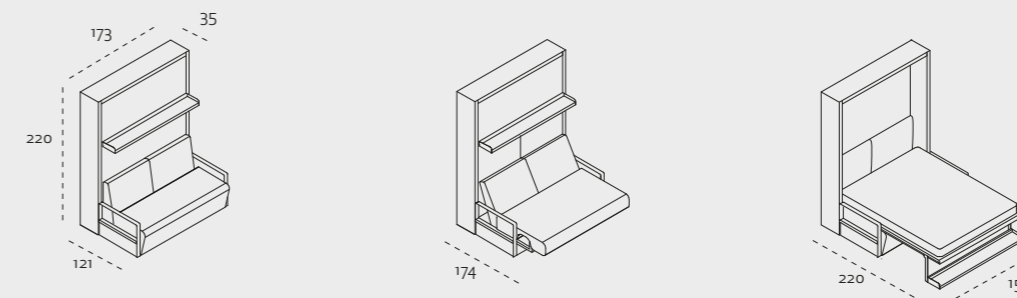

## Atoll

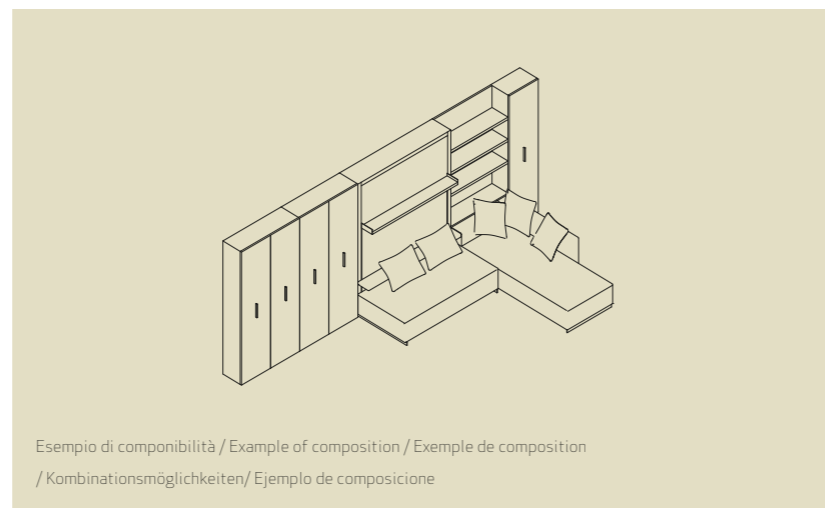
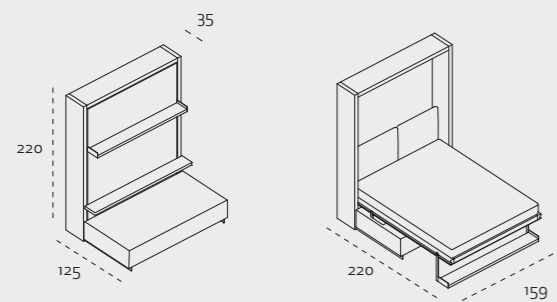

## Swing

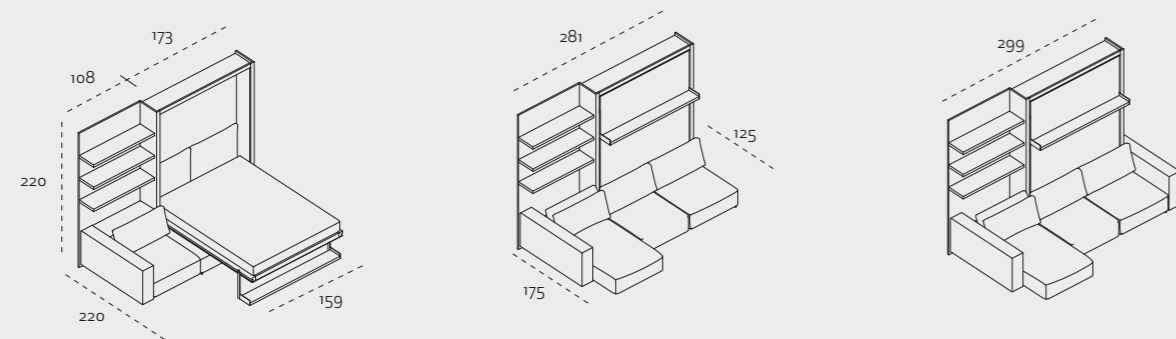

lgm

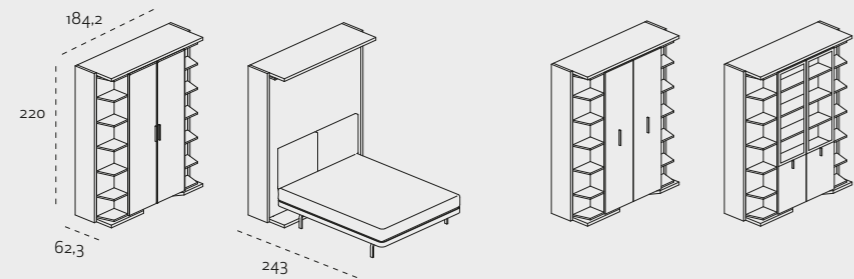

lgs

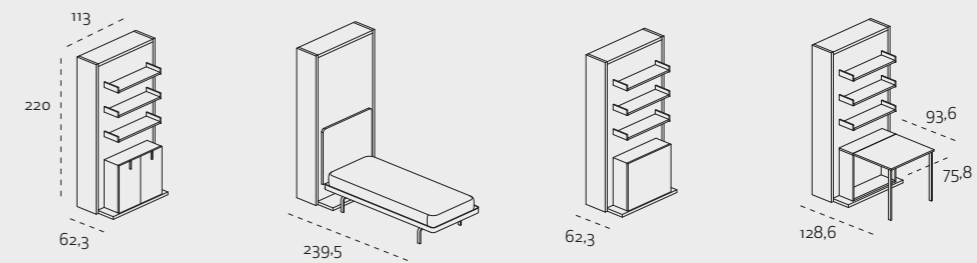

lgm 01

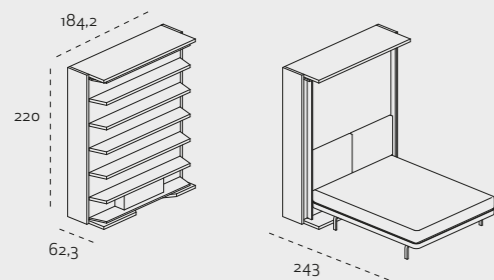

lgm 01 tavolo

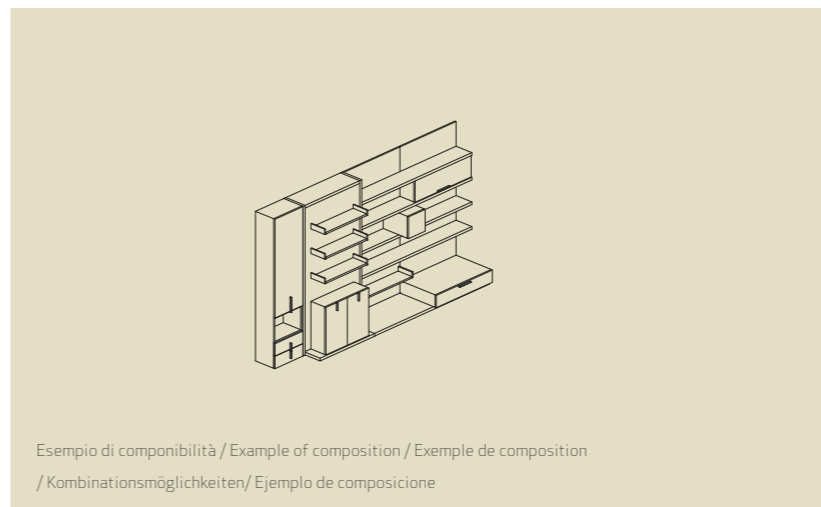
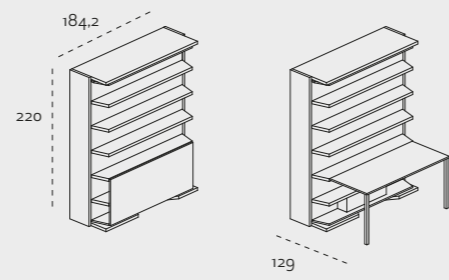

lgm 02

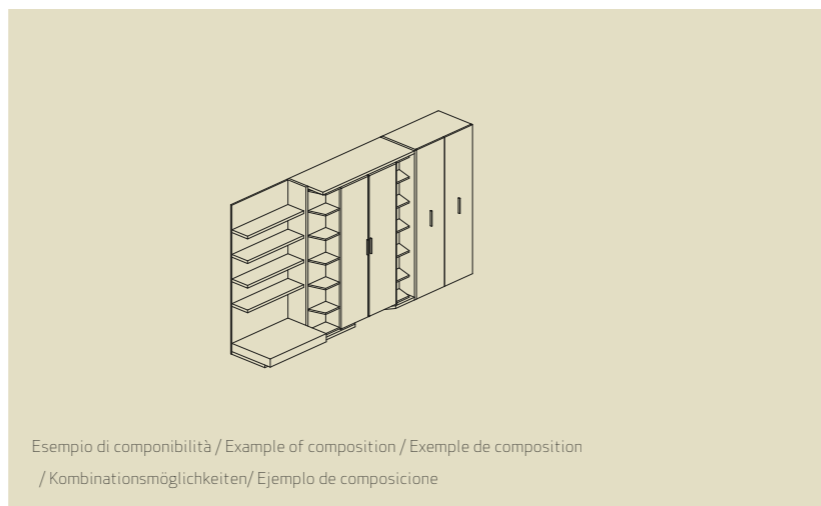
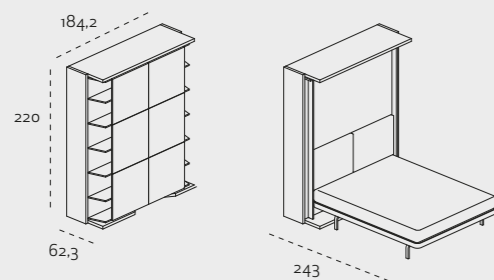



## Poppi 90

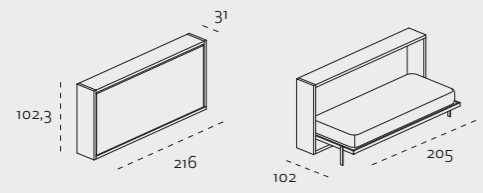

## Poppi Desk 90

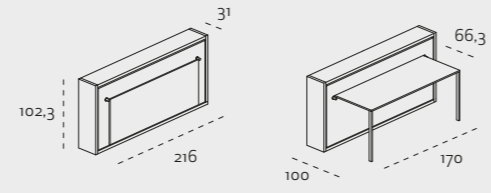

## Poppi Sd 90

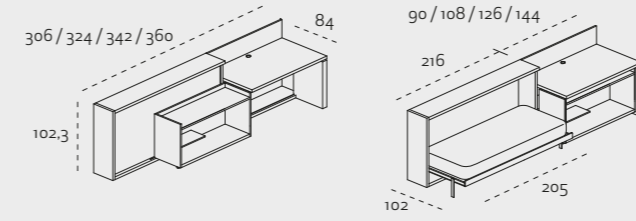

## Poppi Sd 120

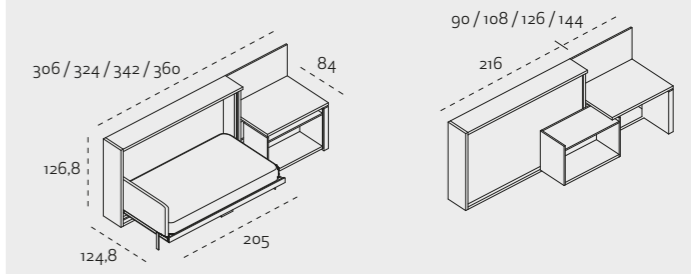

## Poppi Book 90

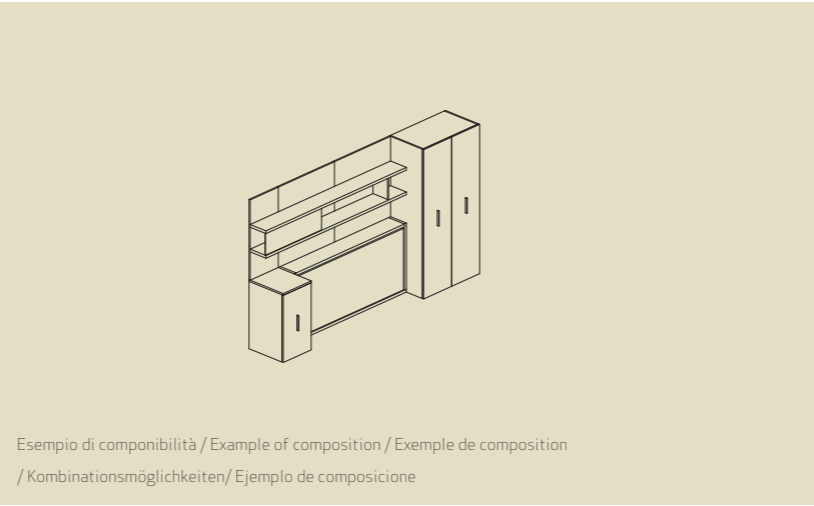
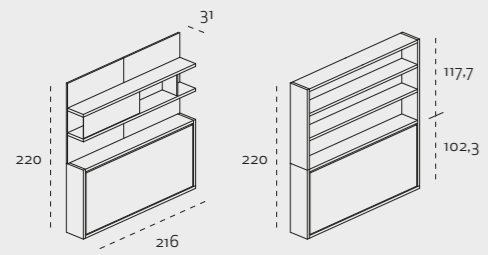

## Poppi Theatre

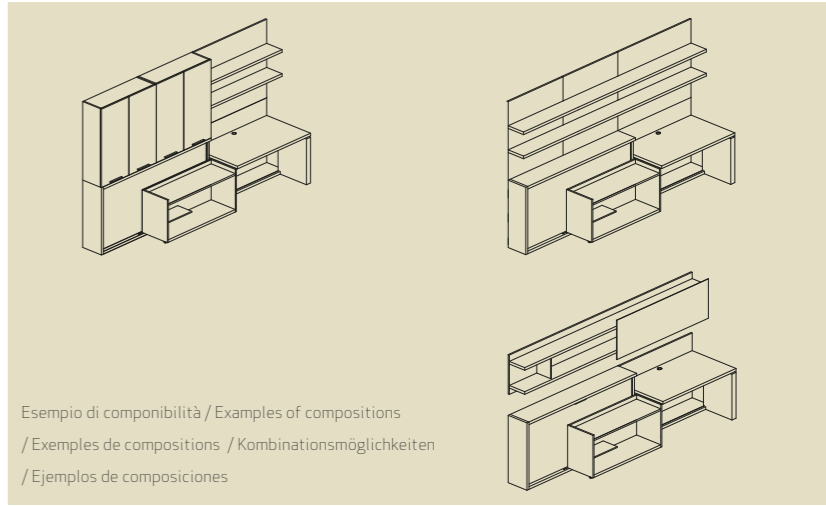
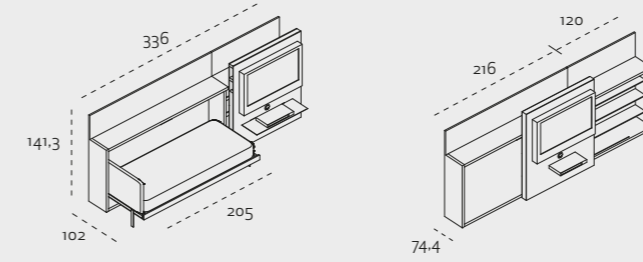

## Poppi 120

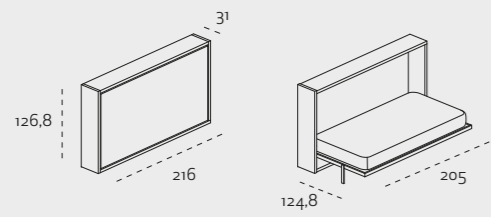

## Poppi Desk 120

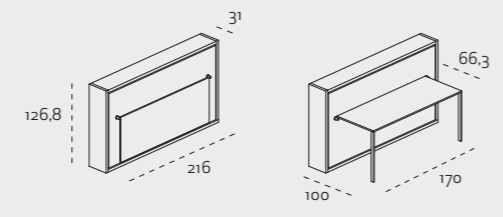

## Poppi Ponte 220

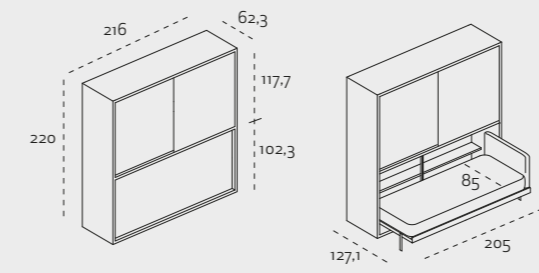

## Poppi Ponte 256

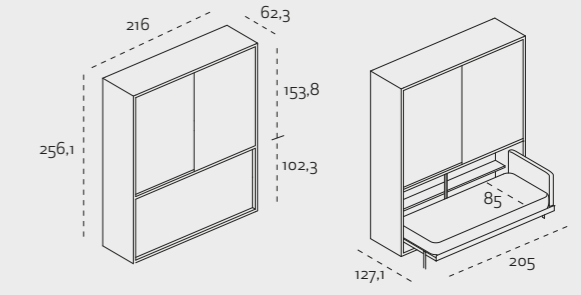

## Poppi Board

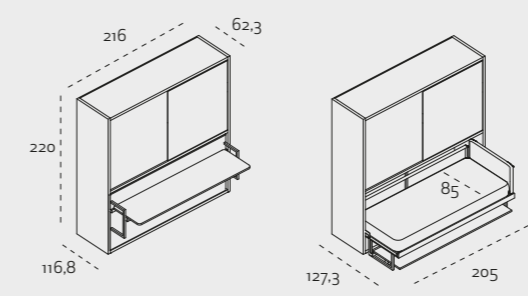

## Poppi Board 256

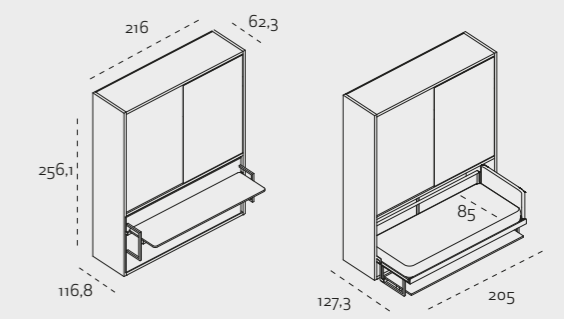

Lollisoft

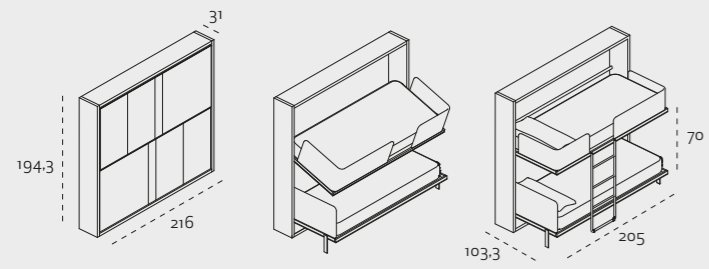

Lollisoft Desk

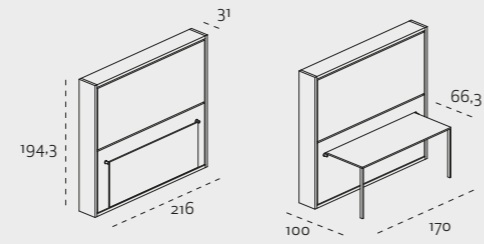

Altea 90

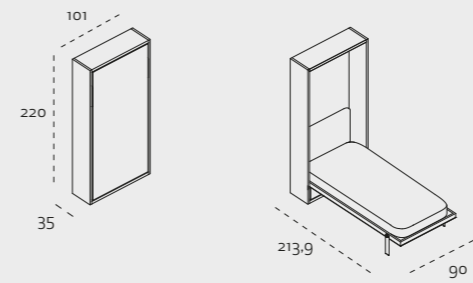

Altea 120

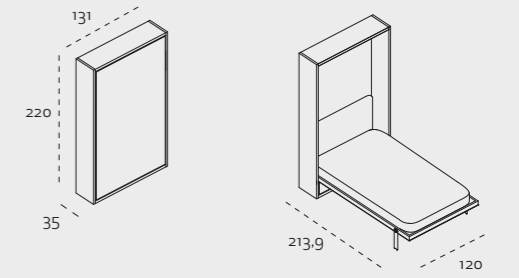

Lollisoft In

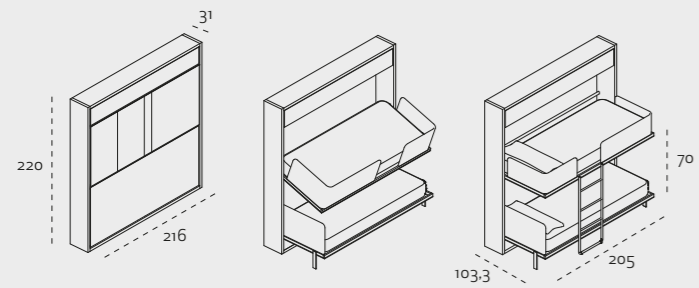

Lollisoft In Desk

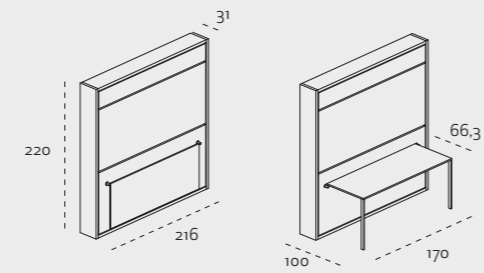

Altea Book 90

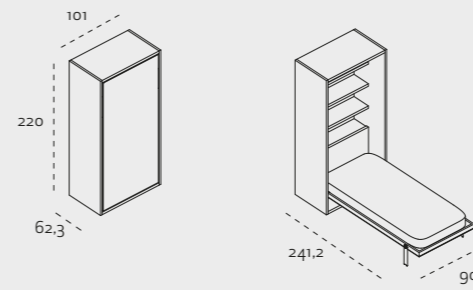

Altea Book 120

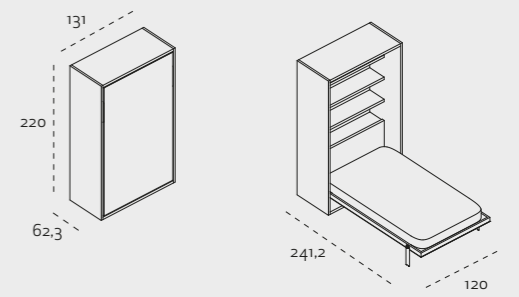

Lollisoft Sd

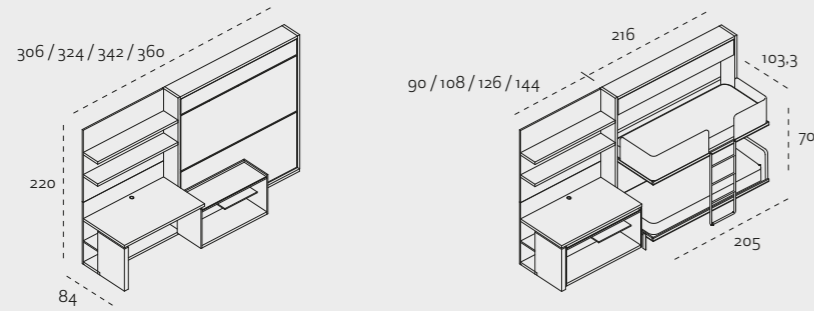

Altea Relax 90

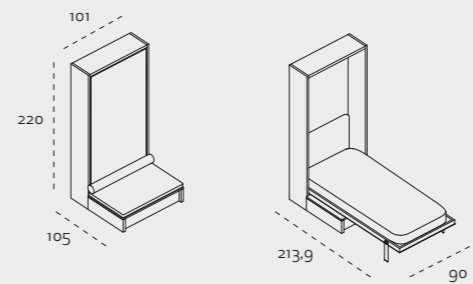

Altea Relax 120

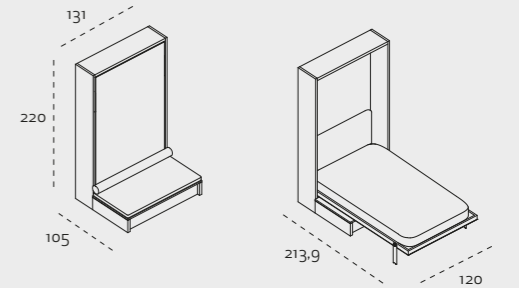

Lollibook

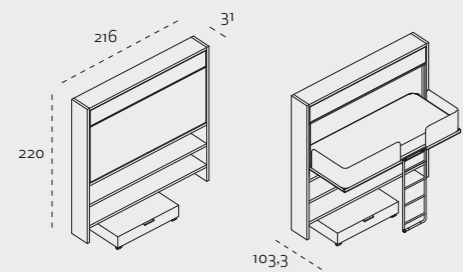

Lolli Desk

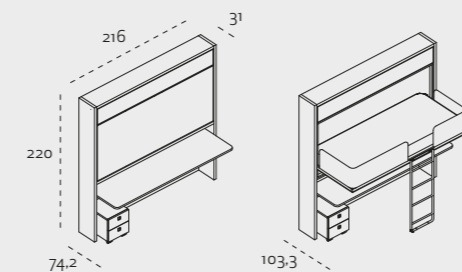

## Telemaco Desk 90

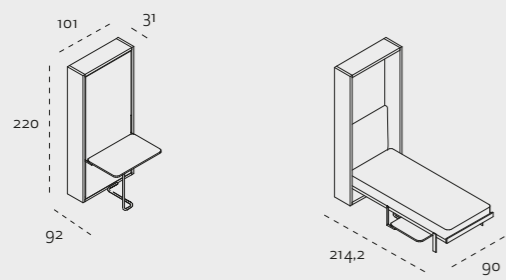

## Telemaco Desk 120

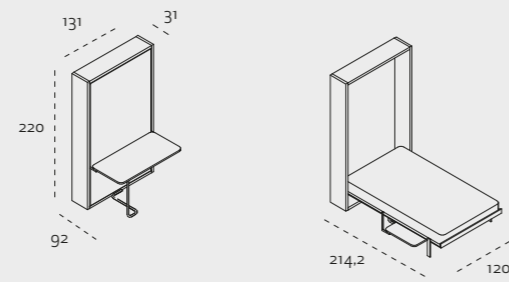

## Penelope

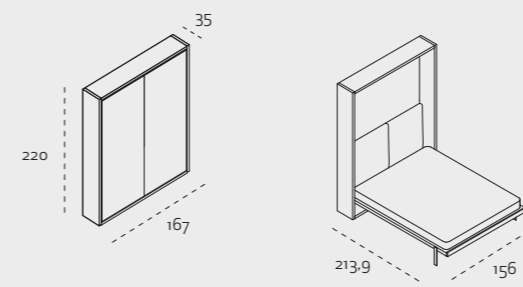

## Penelope Sofa

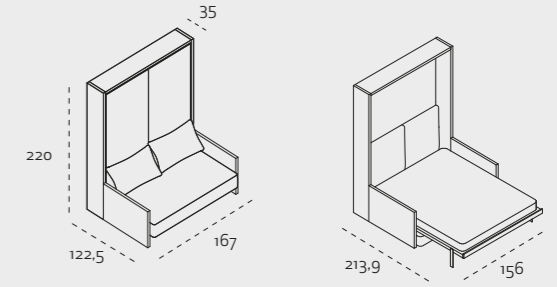

## Telemaco Work

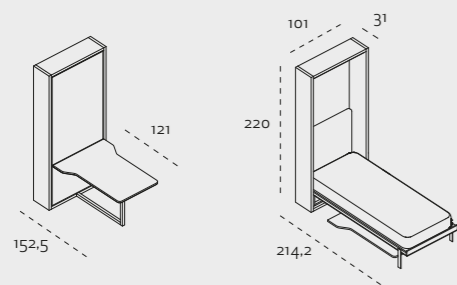

## Circe

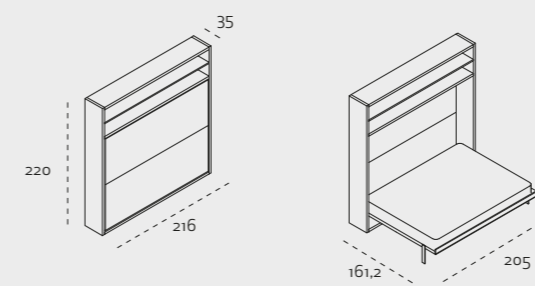

## Circe Sofa

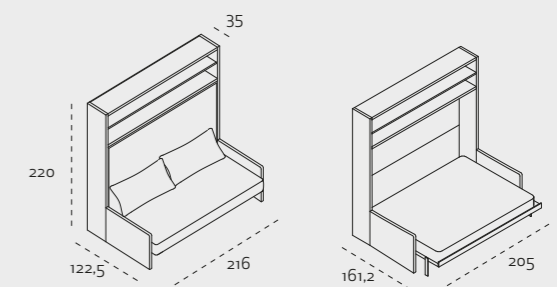

## Ulisse Desk

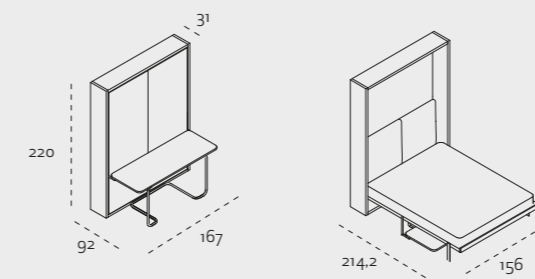

## Ulisse Dining

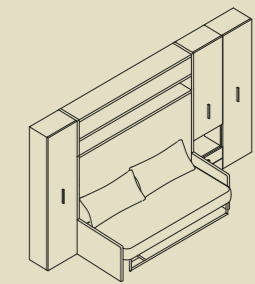
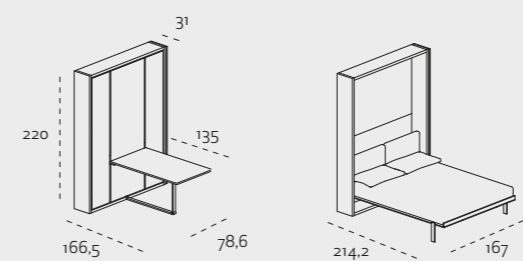

Esempio di componibilità / Example of composition / Exemple de composition  
/ Kombinationsmöglichkeiten / Ejemplo de composición

Doc.

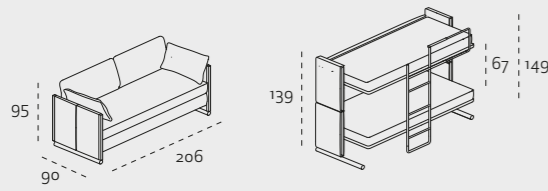

Doc. XI

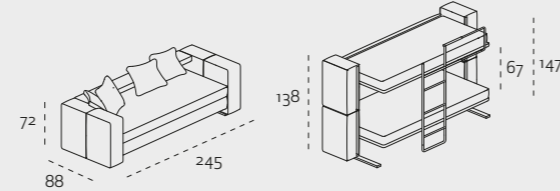

Cabrio in

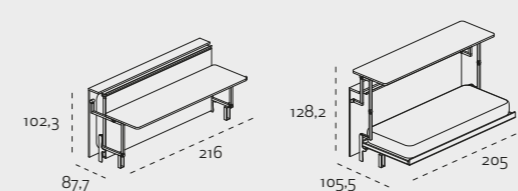

Felix fisso 90 / 120

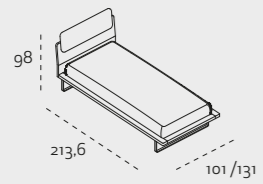

Felix su ruote 90 / 120

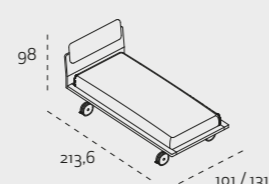

Felix 90 / 120

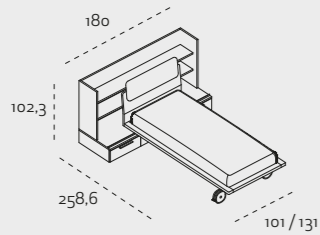

Speedy

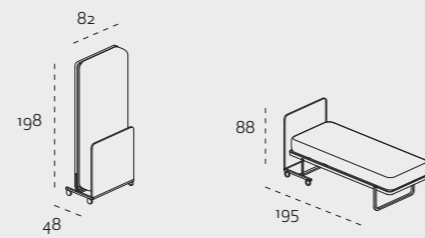

Cabrio In 102

Esempio di componibilità / Examples of compositions / Exemples de compositions / Kombinationsmöglichkeiten / Ejemplos de composiciones

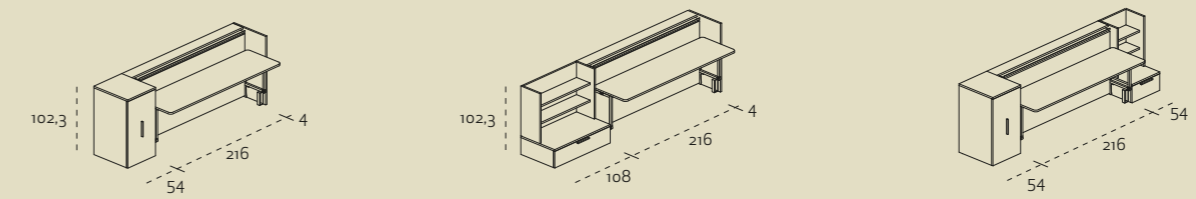

Cabrio In 102 + Mensola

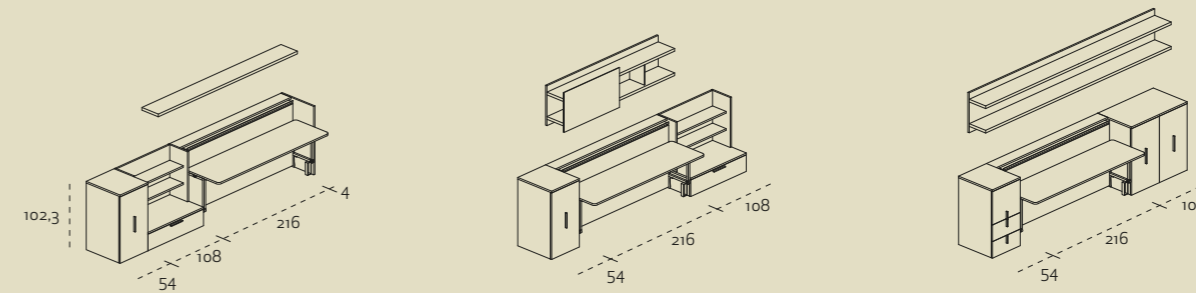

Cabrio In 220

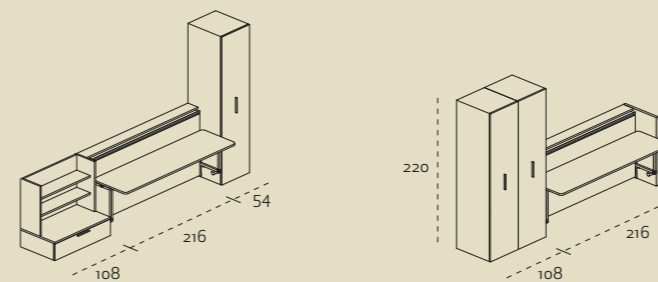

Cabrio In 256

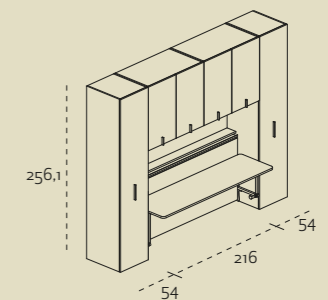

# Clei

Industria per l'arredamento trasformabile di case e comunita', ha sede in Brianza e vanta origini lontane nel tempo. Nasce nel 1962 con una forte propensione al nuovo puntando sulla specializzazione del prodotto attraverso la progettazione finalizzata alla trasformabilità ed integrabilità di programmi per l'arredo dell'ospitalità e della casa. La struttura della divisione contract e' appoggiata alla struttura produttiva centrale, prevede le fasi di consulenza, progettazione, realizzazione prototipi ed interpreta ogni intervento secondo le esigenze funzionali ed estetiche, con la massima liberta' progettuale ed un servizio di assistenza globale.

Clei, manufacturer of transformable systems for home and contract market, is based in Brianza (North of Italy) and boasts origins back in time. The company was established in 1962 with a great idea of innovation and product specialization through design focused on transformability and integrated programs.

The contract division is supported by the main manufacturing structure, providing with consulting, projecting and realization of prototypes; each step is done according to the functional and aesthetical requirements, with total freedom in project and full assistance.

Clei, industrie pour l'ameublement transformable de maisons et collectivités, a son siège en Brianza (Nord de l'Italie) depuis longtemps. Elle a été fondée en 1962 avec une forte propension pour la nouveauté, en mirant sur des projets finalisés à la transformation et l'intégration des programmes pour l'ameublement.

La division « contract » soutenue par la structure de production centrale, prévoit les phases de conseil, conception, réalisation des prototypes: chacune selon les exigences fonctionnelles et esthétiques avec une grande liberté de projet et un service d'assistance globale.

Clei, Hersteller von wandelbaren Systemen für den Wohn- und Objektbereich, mit Sitz und Ursprung in Brianza (Norditalien). Das Unternehmen wurde im Jahr 1962 gegründet mit der großen Idee innovative, designorientierte verwandelbare Möbel mit Mehrfachnutzung zu produzieren. Die Projektteilung wird durch die Fertigungsstruktur und das Projektteam gestützt, vorbereitend und beratend zur Erarbeitung der einzelnen Kundenprojekte. Im Hinblick zur Realisierung der einzelnen Projekte und dem Bau der Prototypen wirkt das Team auf jede funktionale und ästhetische Anforderung des einzelnen Projekts mit ein.

Clei, industria para el amueblamiento transformable de casas y colectividades esta situado en Brianza y se enorgullece de sus orígenes antiguos. Nació en 1962, con una fuerte inclinación por la novedad y apostando por proyectos basados en la transformación et integración de los muebles en la decoración de la casas, para una mejor hospitalidad. Clei trabaja en Italia y en el extranjero a través de una red de distribuidores e importadores. La organización de la división "contract", sostenida por la estructura de la producción central, prevee las fases de asesoramiento, creación y realización de prototipos. Los trabajos son realizados acorde con las necesidades funcionales y estéticas, con una gran libertad en los proyectos y un servicio global de post venta.





